

SPICE thermal model

BUK9Y22-30B

Symbol	Parameter	Conditions	Min	Typ	Max	Unit
$R_{th(j-mb)}$	thermal resistance from junction to mounting base		-	-	2.53	K/W

C_{th1}	1.131E-02 F
C_{th2}	1.786E-03 F
C_{th3}	4.474E-04 F
C_{th4}	1.121E-04 F
C_{th5}	2.808E-05 F
C_{th6}	7.035E-06 F
C_{th7}	1.763E-06 F
C_{th8}	4.416E-07 F
R_{th1}	1.591E+00 Ω
R_{th2}	6.822E-01 Ω
R_{th3}	1.843E-01 Ω
R_{th4}	4.977E-02 Ω
R_{th5}	1.344E-02 Ω
R_{th6}	3.631E-03 Ω
R_{th7}	9.809E-04 Ω
R_{th8}	2.650E-04 Ω

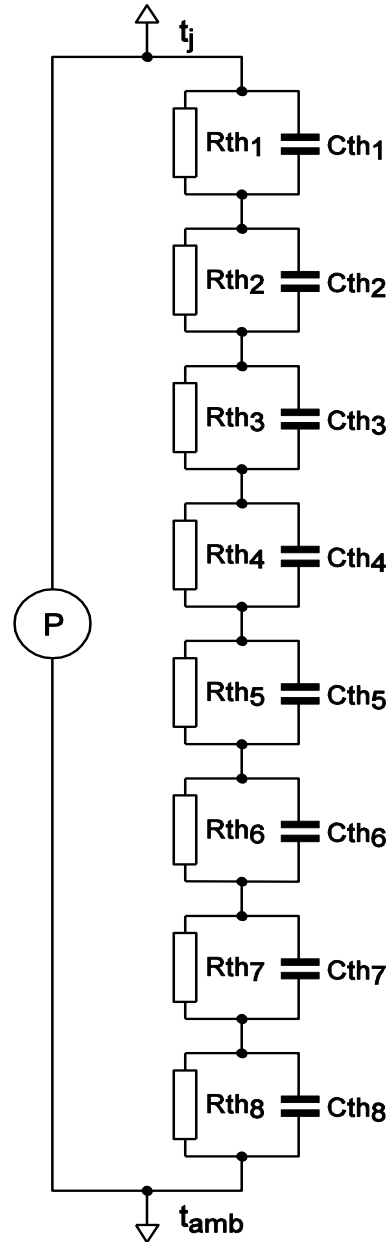

001aal768

Part: BUK9Y22-30B
 Version: 1
 Date: 23-3-2010
 Rth: 2.53