

SPICE thermal model

BUK9M6R6-30E

Symbol	Parameter	Conditions	Min	Typ	Max	Unit
$R_{th(j-mb)}$	thermal resistance from junction to mounting base		-	-	2.00	K/W

C_{th1}	2.117E-05 F
C_{th2}	1.868E-04 F
C_{th3}	2.444E-04 F
C_{th4}	2.967E-03 F
C_{th5}	1.698E-03 F
C_{th6}	6.259E-03 F
C_{th7}	8.221E-02 F
C_{th8}	2.085E+02 F

R_{th1}	2.884E-03 Ω
R_{th2}	5.970E-03 Ω
R_{th3}	2.837E-02 Ω
R_{th4}	3.855E-02 Ω
R_{th5}	5.033E-01 Ω
R_{th6}	1.154E+00 Ω
R_{th7}	2.626E-01 Ω
R_{th8}	3.109E-03 Ω

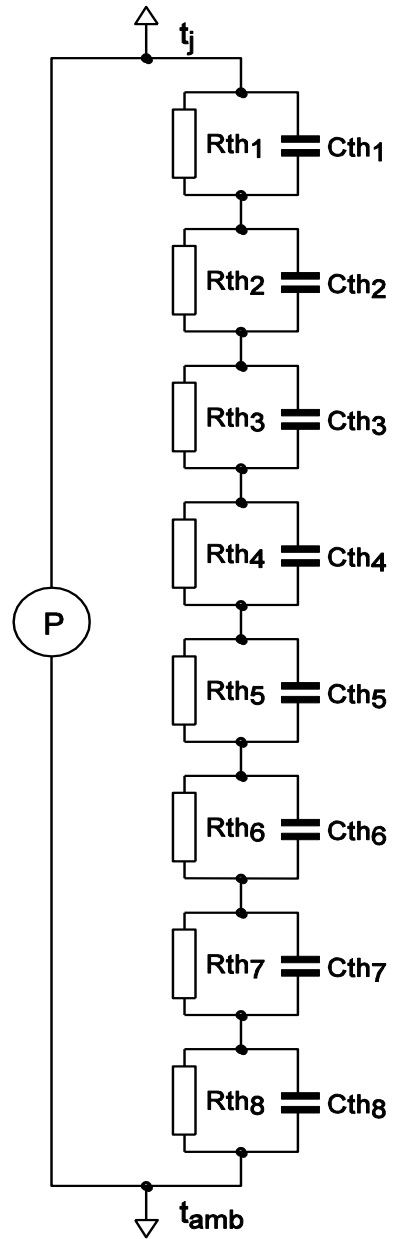

001aal768

Part: BUK9M6R6-30E
 Date: 3/3/2016
 Model Rth 2.00 K/W