

SPICE thermal model

BUK9M34-100E

Symbol	Parameter	Conditions	Min	Typ	Max	Unit
$R_{th(j-mb)}$	thermal resistance from junction to mounting base		-	-	1.89	K/W

C_{th1}	2.419E-05 F
C_{th2}	2.167E-04 F
C_{th3}	3.323E-04 F
C_{th4}	2.213E-03 F
C_{th5}	3.420E-03 F
C_{th6}	6.196E-03 F
C_{th7}	2.541E-02 F
C_{th8}	4.000E+01 F
R_{th1}	2.335E-03 Ω
R_{th2}	4.887E-03 Ω
R_{th3}	2.084E-02 Ω
R_{th4}	4.805E-02 Ω
R_{th5}	3.344E-01 Ω
R_{th6}	1.432E+00 Ω
R_{th7}	3.993E-02 Ω
R_{th8}	7.333E-03 Ω

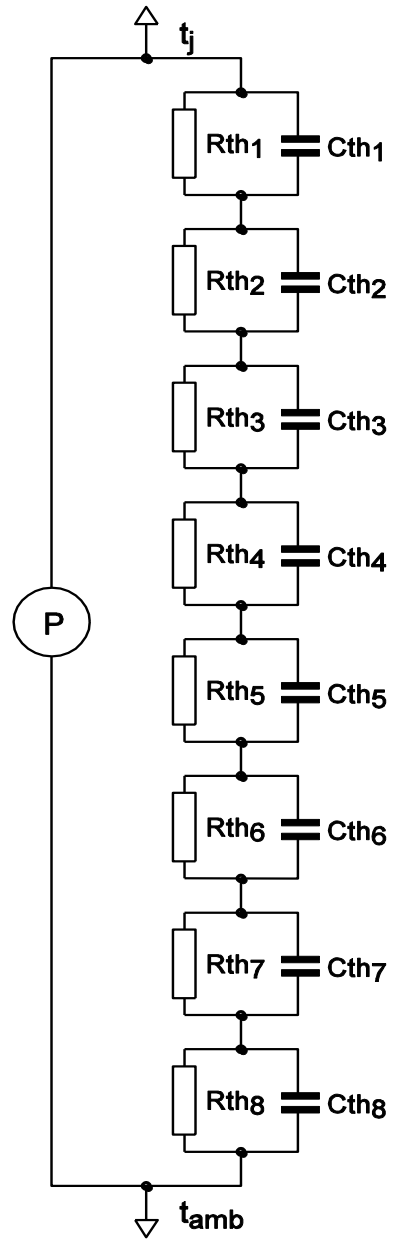

001aal768

Part: BUK9M34-100E
 Date: 3/3/2016
 Model Rth 1.89 K/W