

SPICE thermal model

BUK9M24-60E

Symbol	Parameter	Conditions	Min	Typ	Max	Unit
$R_{th(j-mb)}$	thermal resistance from junction to mounting base		-	-	2.75	K/W

C_{th1}	1.598E-05 F
C_{th2}	1.754E-04 F
C_{th3}	1.300E-04 F
C_{th4}	8.034E-03 F
C_{th5}	8.275E-04 F
C_{th6}	6.710E-03 F
C_{th7}	7.777E-02 F
C_{th8}	8.620E+01 F
R_{th1}	3.930E-03 Ω
R_{th2}	6.913E-03 Ω
R_{th3}	4.368E-02 Ω
R_{th4}	1.751E-02 Ω
R_{th5}	1.045E+00 Ω
R_{th6}	1.260E+00 Ω
R_{th7}	3.643E-01 Ω
R_{th8}	3.262E-03 Ω

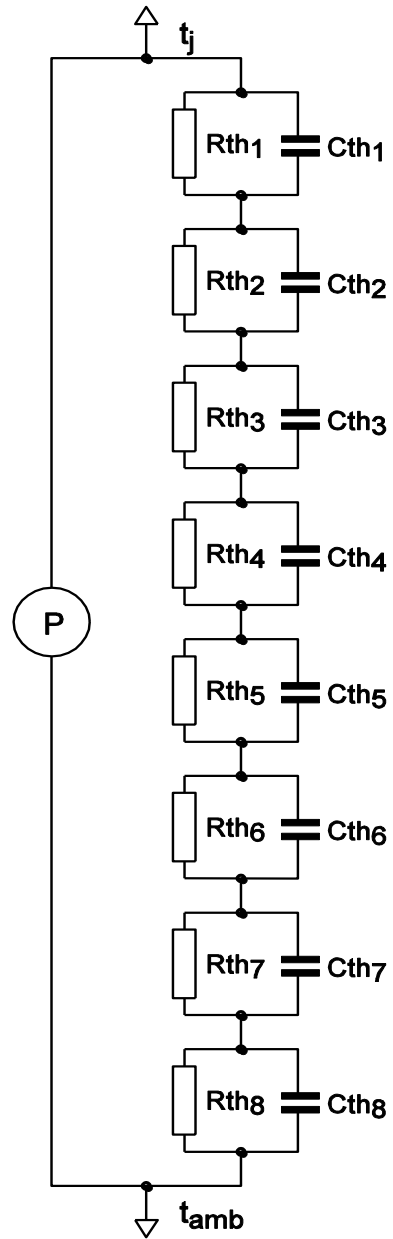

001aal768

Part: BUK9M24-60E
 Date: 3/3/2016
 Model Rth 2.75 K/W