

## SPICE thermal model

BUK9K8R7-40E

Symbol	Parameter	Conditions	Min	Typ	Max	Unit
$R_{th(j-mb)}$	thermal resistance from junction to mounting base		-	-	2.84	K/W

$C_{th1}$	2.695E-05 F
$C_{th2}$	1.471E-04 F
$C_{th3}$	2.047E-04 F
$C_{th4}$	9.149E-04 F
$C_{th5}$	3.724E-03 F
$C_{th6}$	4.432E-03 F
$C_{th7}$	1.513E-01 F
$R_{th1}$	3.337E-03 $\Omega$
$R_{th2}$	7.854E-03 $\Omega$
$R_{th3}$	4.778E-02 $\Omega$
$R_{th4}$	1.011E-01 $\Omega$
$R_{th5}$	3.141E-01 $\Omega$
$R_{th6}$	1.966E+00 $\Omega$
$R_{th7}$	4.039E-01 $\Omega$

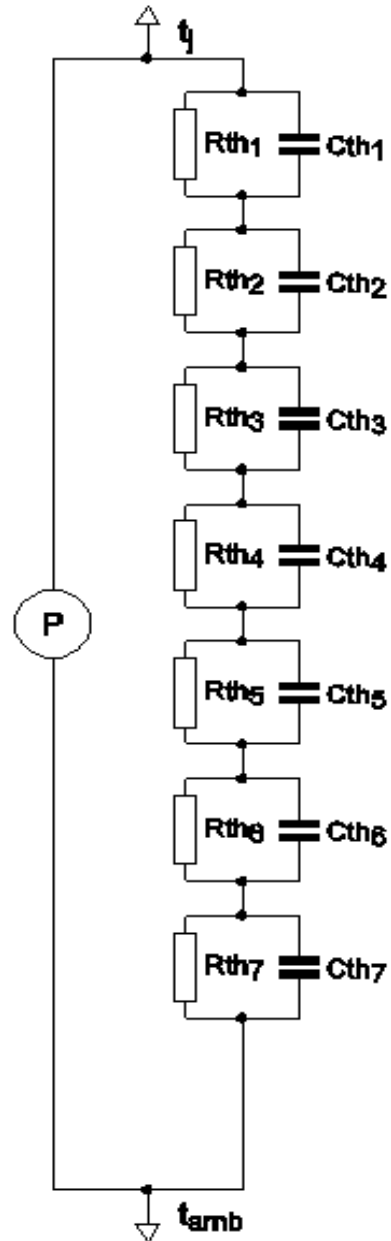

Part: BUK9K8R7-40E  
 Date: 20/3/2013  
 Rth 2.84 K/W