

## SPICE thermal model

BUK7M22-80E

Symbol	Parameter	Conditions	Min	Typ	Max	Unit
$R_{th(j-mb)}$	thermal resistance from junction to mounting base		-	-	2.00	K/W

$C_{th1}$	2.117E-05 F
$C_{th2}$	1.868E-04 F
$C_{th3}$	2.444E-04 F
$C_{th4}$	2.967E-03 F
$C_{th5}$	1.698E-03 F
$C_{th6}$	6.259E-03 F
$C_{th7}$	8.221E-02 F
$C_{th8}$	2.085E+02 F
$R_{th1}$	2.884E-03 $\Omega$
$R_{th2}$	5.970E-03 $\Omega$
$R_{th3}$	2.837E-02 $\Omega$
$R_{th4}$	3.855E-02 $\Omega$
$R_{th5}$	5.033E-01 $\Omega$
$R_{th6}$	1.154E+00 $\Omega$
$R_{th7}$	2.626E-01 $\Omega$
$R_{th8}$	3.109E-03 $\Omega$

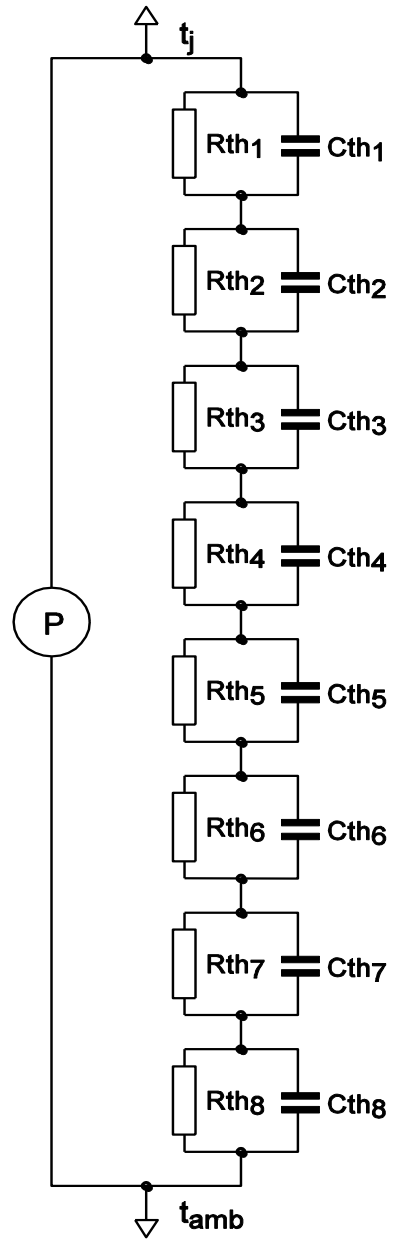

001aal768

Part: BUK7M22-80E  
 Date: 9/5/2016  
 Model Rth 2.00 K/W