

## SPICE thermal model

BUK7M19-60E

Symbol	Parameter	Conditions	Min	Typ	Max	Unit
$R_{th(j-mb)}$	thermal resistance from junction to mounting base		-	-	2.75	K/W

$C_{th1}$	1.598E-05 F
$C_{th2}$	1.754E-04 F
$C_{th3}$	1.300E-04 F
$C_{th4}$	8.034E-03 F
$C_{th5}$	8.275E-04 F
$C_{th6}$	6.710E-03 F
$C_{th7}$	7.777E-02 F
$C_{th8}$	8.620E+01 F
$R_{th1}$	3.930E-03 $\Omega$
$R_{th2}$	6.913E-03 $\Omega$
$R_{th3}$	4.368E-02 $\Omega$
$R_{th4}$	1.751E-02 $\Omega$
$R_{th5}$	1.045E+00 $\Omega$
$R_{th6}$	1.260E+00 $\Omega$
$R_{th7}$	3.643E-01 $\Omega$
$R_{th8}$	3.262E-03 $\Omega$

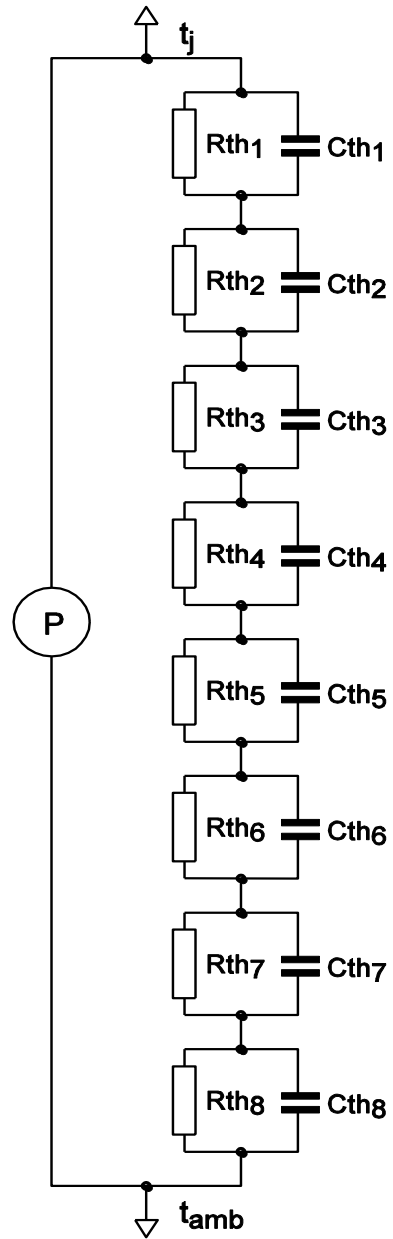

001aal768

Part: BUK7M19-60E  
 Date: 3/3/2016  
 Model Rth 2.75 K/W