

SPICE thermal model

BUK7M15-60E

Symbol	Parameter	Conditions	Min	Typ	Max	Unit
$R_{th(j-mb)}$	thermal resistance from junction to mounting base		-	-	2.44	K/W

C_{th1}	2.010E-05 F
C_{th2}	1.708E-04 F
C_{th3}	1.888E-04 F
C_{th4}	7.066E-03 F
C_{th5}	1.019E-03 F
C_{th6}	9.129E-03 F
C_{th7}	9.134E-02 F
C_{th8}	2.243E+02 F
R_{th1}	4.007E-03 Ω
R_{th2}	6.986E-03 Ω
R_{th3}	4.049E-02 Ω
R_{th4}	1.746E-02 Ω
R_{th5}	1.084E+00 Ω
R_{th6}	1.072E+00 Ω
R_{th7}	2.058E-01 Ω
R_{th8}	4.457E-03 Ω

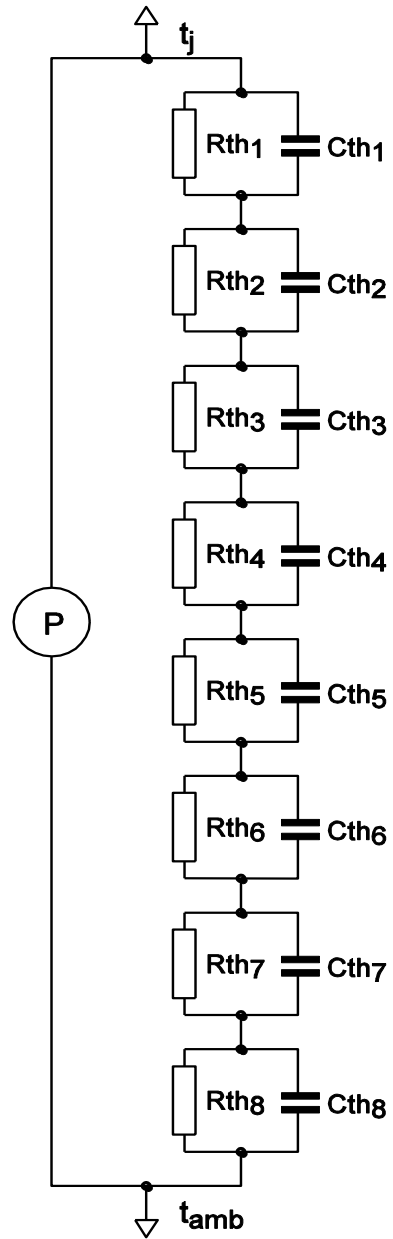

001aal768

Part: BUK7M15-60E
 Date: 3/3/2016
 Model Rth 2.44 K/W