

SPICE thermal model

BUK753R1-40E

Symbol	Parameter	Conditions	Min	Typ	Max	Unit
$R_{th(j-mb)}$	thermal resistance from junction to mounting base		-	-	0.64	K/W

C_{th1}	1.572E-04 F
C_{th2}	1.124E-03 F
C_{th3}	8.462E-04 F
C_{th4}	3.272E-03 F
C_{th5}	1.019E-02 F
C_{th6}	2.118E-02 F
C_{th7}	5.698E-01 F
C_{th8}	1.813E+02 F
R_{th1}	5.654E-04 Ω
R_{th2}	1.114E-03 Ω
R_{th3}	1.315E-02 Ω
R_{th4}	3.159E-02 Ω
R_{th5}	1.138E-01 Ω
R_{th6}	3.999E-01 Ω
R_{th7}	9.381E-02 Ω
R_{th8}	1.005E-03 Ω

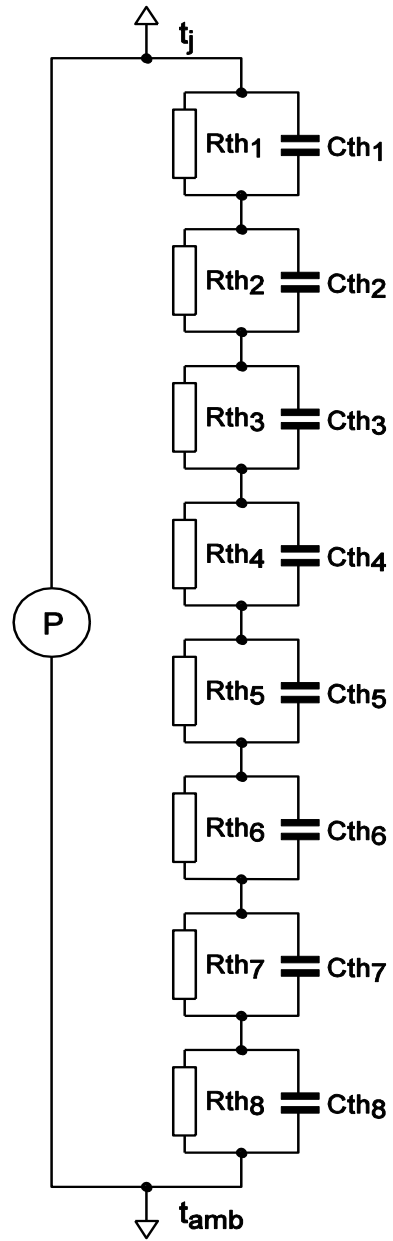

Part: BUK753R1-40E
 Date: 17/4/2013
 Model Rth 0.65 K/W