

Important notice

Dear Customer,

On 7 February 2017 the former NXP Standard Product business became a new company with the tradename **Nexperia**. Nexperia is an industry leading supplier of Discrete, Logic and PowerMOS semiconductors with its focus on the automotive, industrial, computing, consumer and wearable application markets

In data sheets and application notes which still contain NXP or Philips Semiconductors references, use the references to Nexperia, as shown below.

Instead of <http://www.nxp.com>, <http://www.philips.com/> or <http://www.semiconductors.philips.com/>, use <http://www.nexperia.com>

Instead of sales.addresses@www.nxp.com or sales.addresses@www.semiconductors.philips.com, use salesaddresses@nexperia.com (email)

Replace the copyright notice at the bottom of each page or elsewhere in the document, depending on the version, as shown below:

- © NXP N.V. (year). All rights reserved or © Koninklijke Philips Electronics N.V. (year). All rights reserved

Should be replaced with:

- © **Nexperia B.V. (year). All rights reserved.**

If you have any questions related to the data sheet, please contact our nearest sales office via e-mail or telephone (details via salesaddresses@nexperia.com). Thank you for your cooperation and understanding,

Kind regards,

Team Nexperia

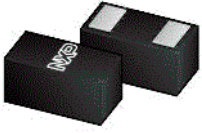

SOD962

Leadless ultra small package; Reel pack, SMD, 7"
Q1/T1 standard product orientation
Orderable part number ending ,315 or YL
Ordering code (12NC) ending 315

Rev. 2 — 20 October 2016

Packing information

1. Packing method

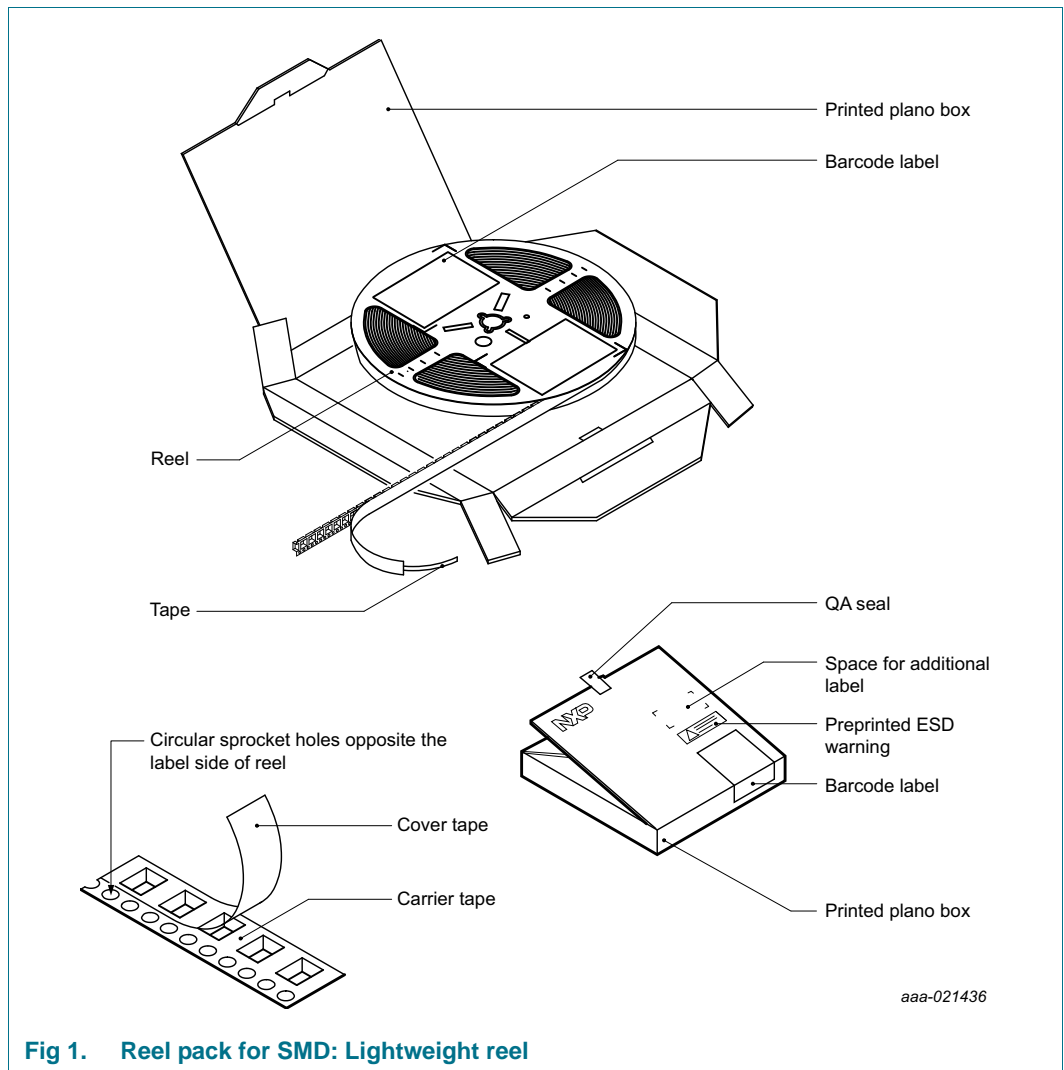

Leadless ultra small package; Reel pack, SMD, 7"
 Q1/T1 standard product orientation
 Orderable part number ending ,315 or YL
 Ordering code (12NC) ending 315

Table 1. Dimensions and quantities

Reel dimensions d × w (mm) [1]	SPQ/PQ (pcs) [2]	Reels per box	Outer box dimensions l × w × h (mm)
180 × 8	9000	1	187 × 187 × 18

[1] d = reel diameter; w = tape width.

[2] Packing quantity dependent on specific product type.

View ordering and availability details at [NXP order portal](#), or contact your local NXP representative.

2. Product orientation

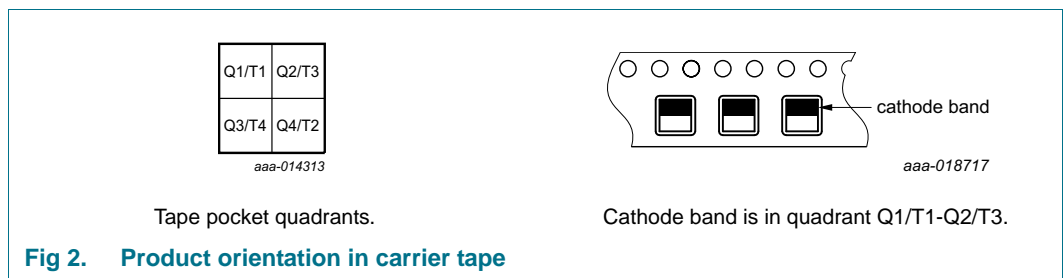

3. Carrier tape dimensions

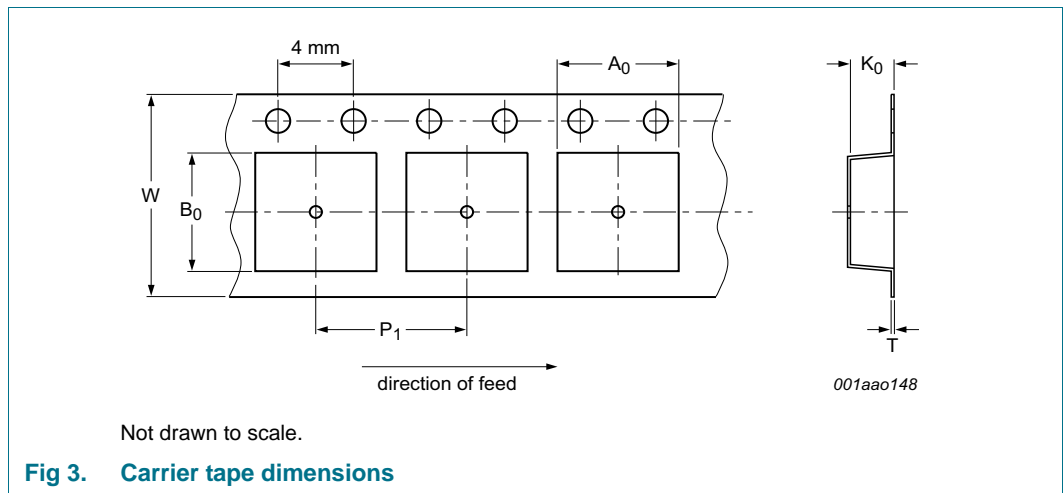

Table 2. Carrier tape dimensions

In accordance with IEC 60286-3.

A ₀ (mm)	B ₀ (mm)	K ₀ (mm)	T (mm)	P ₁ (mm)	W (mm)
0.34 ± 0.02	0.67 ± 0.03	0.35 ± 0.03	0.20 ± 0.02	2.0 ± 0.1	8.0 ± 0.1

Leadless ultra small package; Reel pack, SMD, 7"
 Q1/T1 standard product orientation
 Orderable part number ending ,315 or YL
 Ordering code (12NC) ending 315

4. Reel dimensions

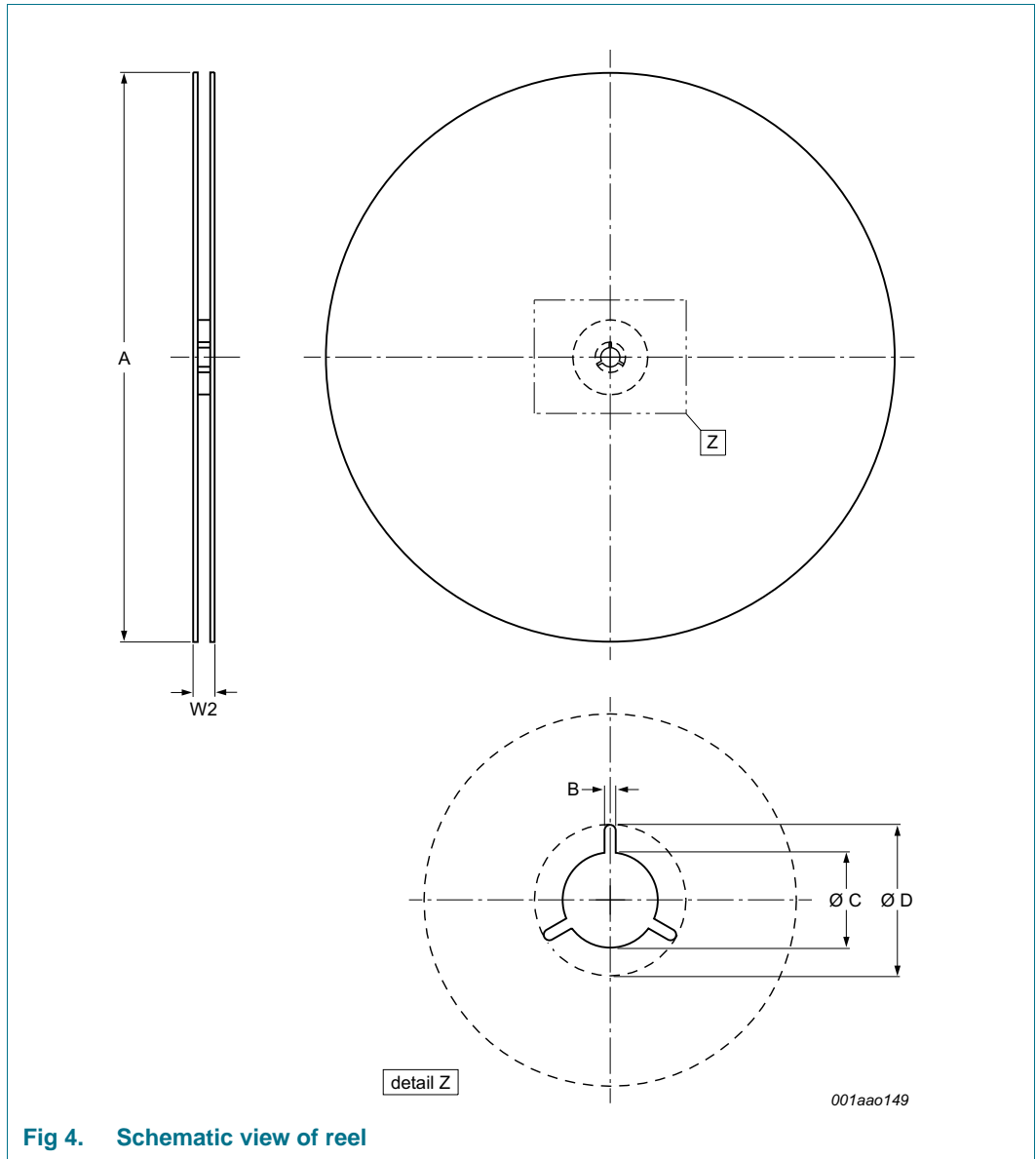

Fig 4. Schematic view of reel

Table 3. Reel dimensions
 In accordance with IEC 60286-3.

A [nom] (mm)	W2 [max] (mm)	B [min] (mm)	C [min] (mm)	D [min] (mm)
180	14.4	1.5	12.8	20.2

Leadless ultra small package; Reel pack, SMD, 7"
 Q1/T1 standard product orientation
 Orderable part number ending ,315 or YL
 Ordering code (12NC) ending 315

5. Barcode label

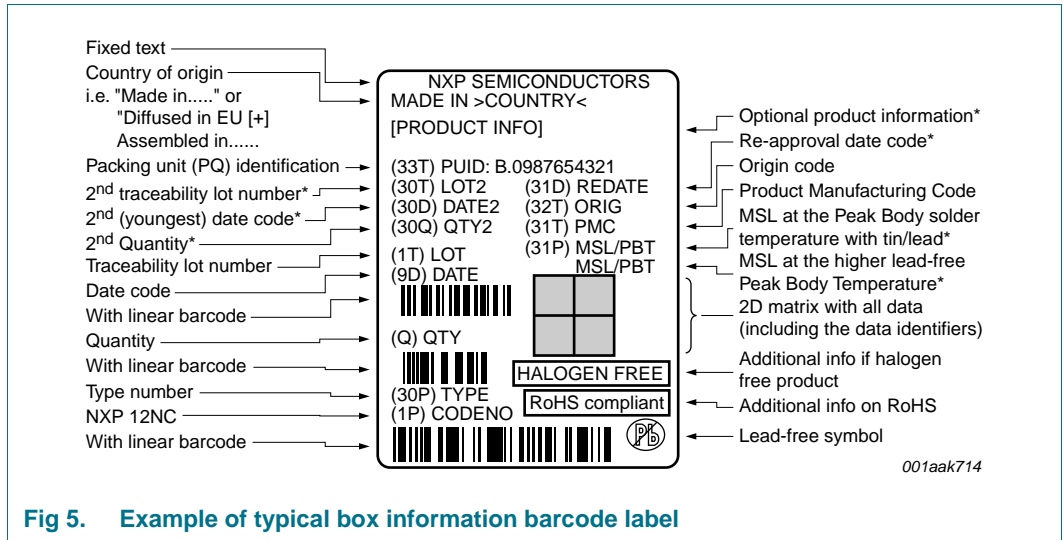

Fig 5. Example of typical box information barcode label

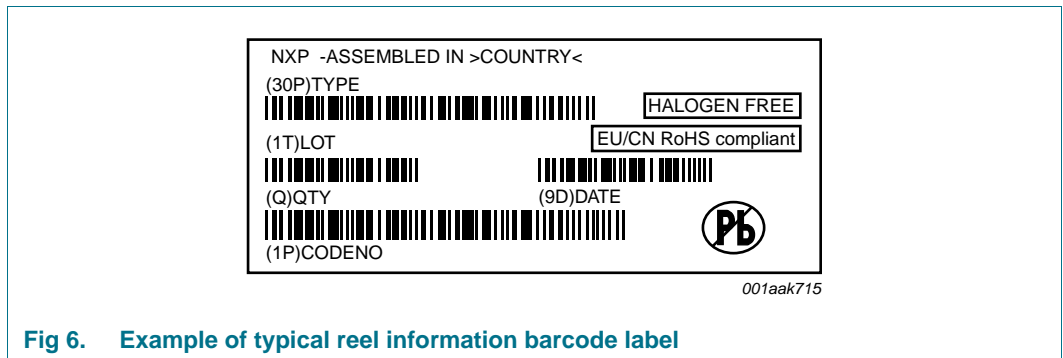

Fig 6. Example of typical reel information barcode label

Table 4. Barcode label dimensions

Box barcode label l x w (mm)	Reel barcode label l x w (mm)
100 x 75	36 x 75

Leadless ultra small package; Reel pack, SMD, 7"
 Q1/T1 standard product orientation
 Orderable part number ending ,315 or YL
 Ordering code (12NC) ending 315

6. Revision history

Table 5. Revision history

Document ID	Release date	Packing document status	Change notice	Supersedes
SOD962_315 v.2 ^[1]	20161020	Packing information	-	-
Modifications:	<ul style="list-style-type: none"> • Light weight reel packing, see Figure 1 “Reel pack for SMD: Lightweight reel” • The format of this packing document has been redesigned to comply with the new identity guidelines of NXP Semiconductors. • Carrier tape dimension update; see Table 2 “Carrier tape dimensions” • Figure 5 “Example of typical box information barcode label” added. 			

[1] This is a released product already using 3NC of 315. BL agreed to keep 315 for all DSN in Q1/T1 to maintain consistency.

Limited warranty and liability

Information in this document is believed to be accurate and reliable. However, NXP Semiconductors does not give any representations or warranties, expressed or implied, as to the accuracy or completeness of such information and shall have no liability for the consequences of use of such information.

© NXP Semiconductors N.V. 2016.

For more information, please visit: <http://www.nxp.com>
 For sales office addresses, please send an email to: salesaddresses@nxp.com

All rights reserved.

Date of release: 20 October 2016
 Document identifier: SOD962_315