

Important notice

Dear Customer,

On 7 February 2017 the former NXP Standard Product business became a new company with the tradename **Nexperia**. Nexperia is an industry leading supplier of Discrete, Logic and PowerMOS semiconductors with its focus on the automotive, industrial, computing, consumer and wearable application markets

In data sheets and application notes which still contain NXP or Philips Semiconductors references, use the references to Nexperia, as shown below.

Instead of <http://www.nxp.com>, <http://www.philips.com/> or <http://www.semiconductors.philips.com/>, use <http://www.nexperia.com>

Instead of sales.addresses@www.nxp.com or sales.addresses@www.semiconductors.philips.com, use salesaddresses@nexperia.com (email)

Replace the copyright notice at the bottom of each page or elsewhere in the document, depending on the version, as shown below:

- © NXP N.V. (year). All rights reserved or © Koninklijke Philips Electronics N.V. (year). All rights reserved

Should be replaced with:

- © **Nexperia B.V. (year). All rights reserved.**

If you have any questions related to the data sheet, please contact our nearest sales office via e-mail or telephone (details via salesaddresses@nexperia.com). Thank you for your cooperation and understanding,

Kind regards,

Team Nexperia

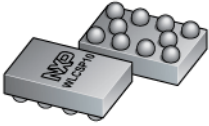

WLCSP10

PCMF2USB3X and PESD2USB3X; H500 and H600;
Reel pack, SMD, 7"

Q2/T3 turned product orientation

Orderable part number ending ,087 or Z

Ordering code (12NC) ending 087

Rev. 2 — 21 March 2016

Packing information

1. Packing method

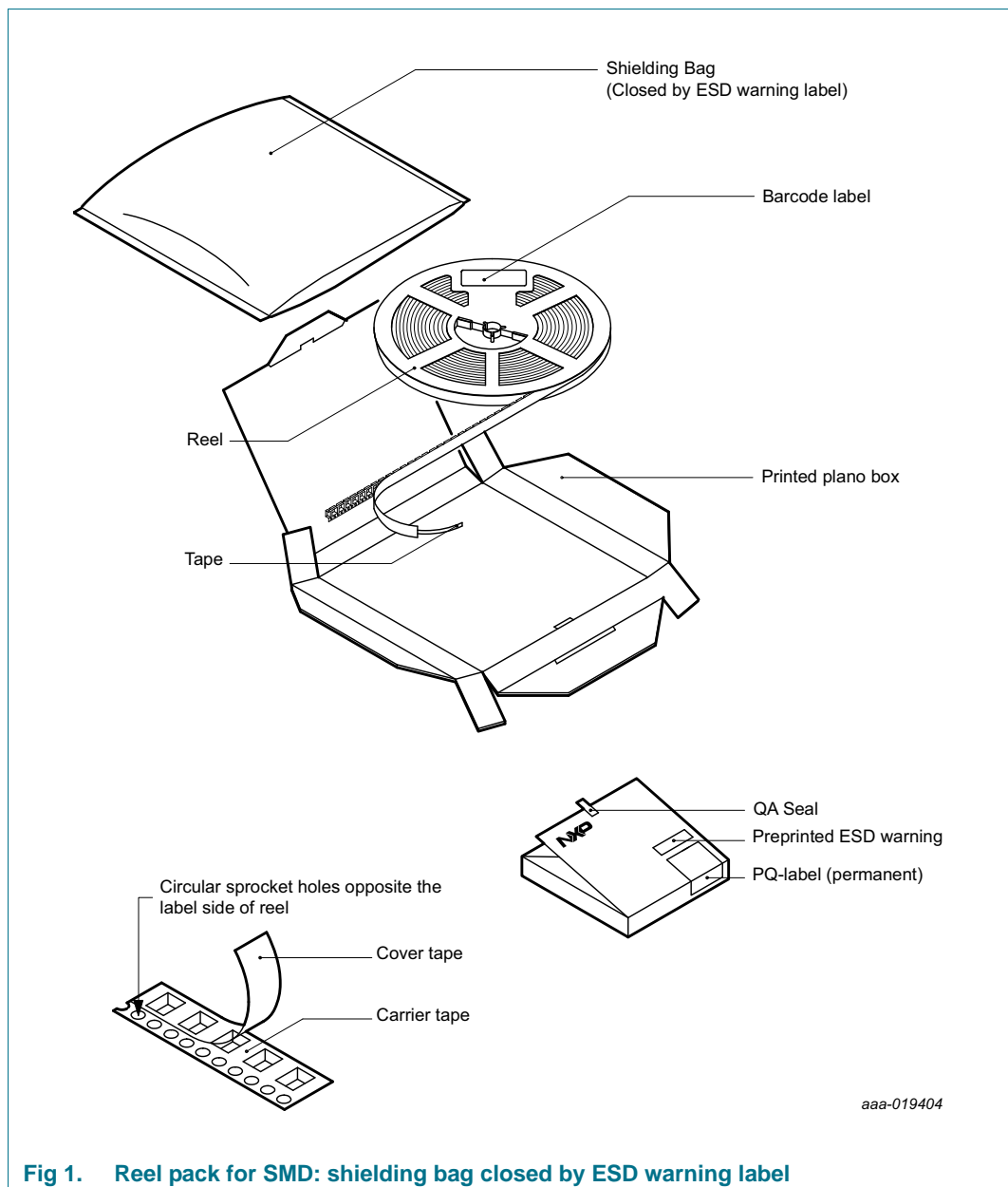

PCMF2USB3X and PESD2USB3X; H500 and H600; Reel pack, SMD, 7" Q2/T3 turned product orientation
 Orderable part number ending ,087 or Z
 Ordering code (12NC) ending 087

Table 1. Dimensions and quantities

Reel dimensions d × w (mm) [1]	SPQ/PQ (pcs) [2]	Reels per box	Outer box dimensions l × w × h (mm)
180 × 8	4500	1	187 × 187 × 18

[1] d = reel diameter; w = tape width.

[2] Packing quantity dependent on specific product type.

View ordering and availability details at [NXP order portal](#), or contact your local NXP representative.

2. Product orientation



Fig 2. Product orientation in carrier tape

3. Carrier tape dimensions

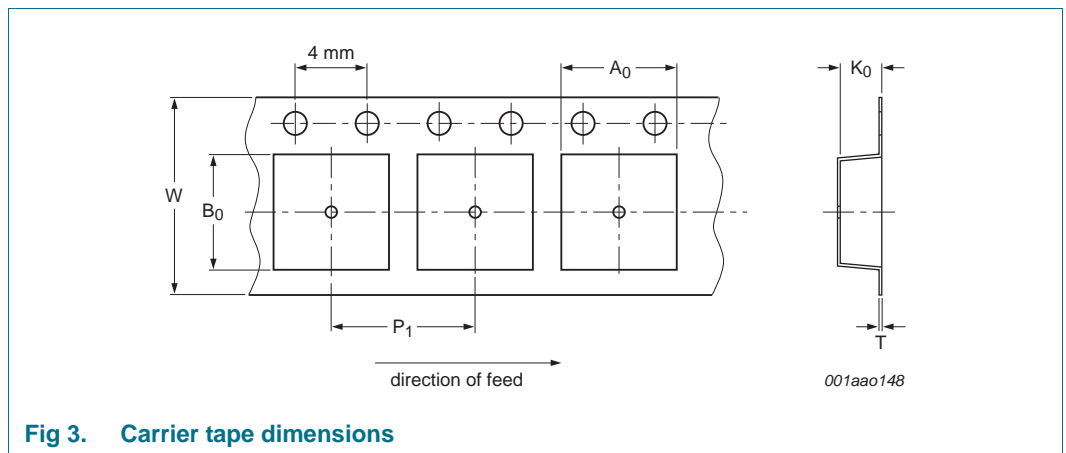

Fig 3. Carrier tape dimensions

Table 2. Carrier tape dimensions

In accordance with IEC 60286-3.

A ₀ (mm)	B ₀ (mm)	K ₀ (mm)	T (mm)	P ₁ (mm)	W (mm)
1.32 ± 0.05	1.72 ± 0.05	0.70 ± 0.05	0.20 ± 0.02	4.0 ± 0.1	8 + 0.3 / - 0.1

4. Reel dimensions

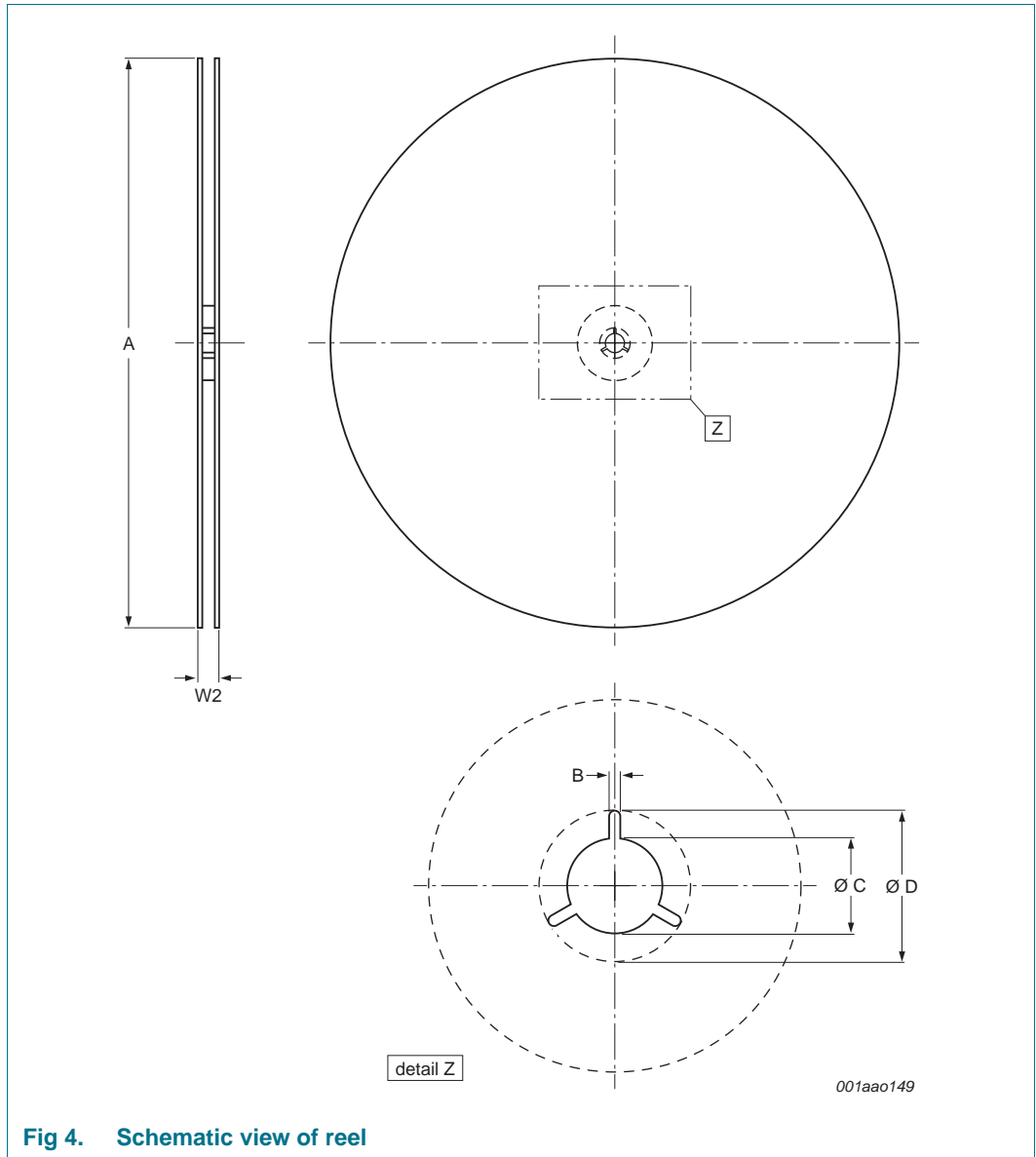

Fig 4. Schematic view of reel

Table 3. Reel dimensions
 In accordance with IEC 60286-3.

A [nom] (mm)	W2 [max] (mm)	B [min] (mm)	C [min] (mm)	D [min] (mm)
180	14.4	1.5	12.8	20.2

5. Barcode label

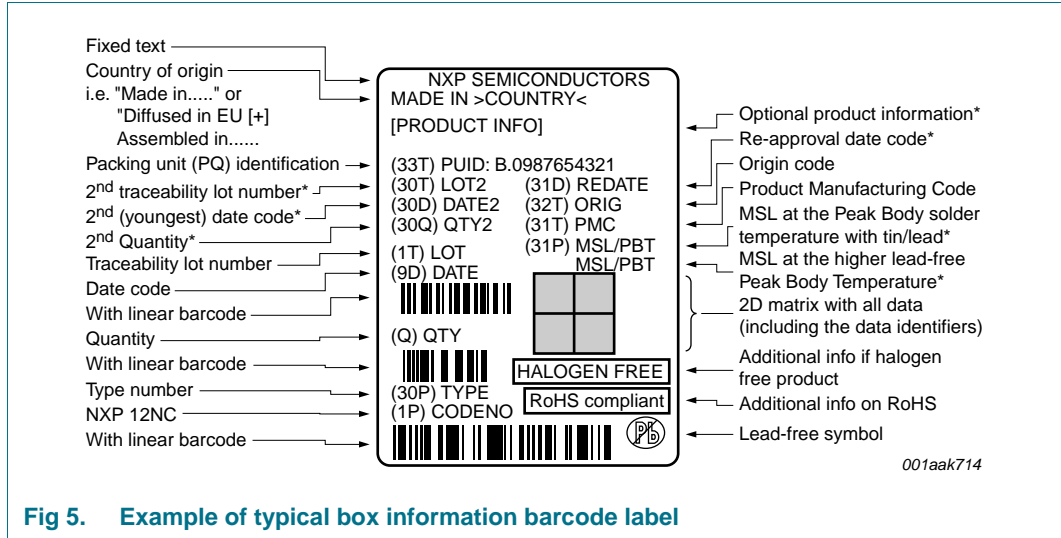

Fig 5. Example of typical box information barcode label

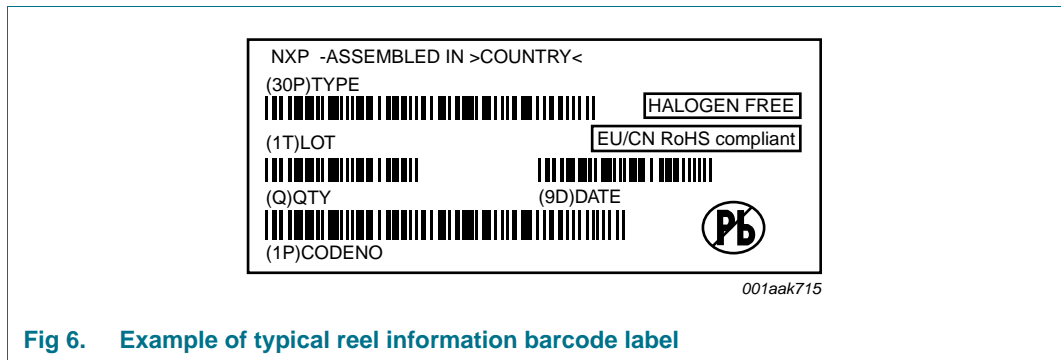

Fig 6. Example of typical reel information barcode label

Table 4. Barcode label dimensions

Box barcode label l x w (mm)	Reel barcode label l x w (mm)
100 x 75	36 x 75

6. Revision history

Table 5. Revision history

Document ID	Release date	Packing document status	Change notice	Supersedes
WLCSP10_PCMF_PESD2USB3X_087 v.2 ^[1]	20160321	Packing information	-	WLCSP10_PCMF2USB30_087 v.1.1
Modifications:	<ul style="list-style-type: none"> Product name changed from PCMF2USB30 to PCMF2USB3X and PESD2USB3X; H500 and H600. Note added to Section 6 "Revision history" referring to product orientation. 			
WLCSP10_PCMF2USB30_087 v.1.1	20150929	Packing information	-	

[1] Orientation in Q2 was approved through a waiver.

Limited warranty and liability

Information in this document is believed to be accurate and reliable. However, NXP Semiconductors does not give any representations or warranties, expressed or implied, as to the accuracy or completeness of such information and shall have no liability for the consequences of use of such information.

© NXP Semiconductors N.V. 2016.

All rights reserved.

For more information, please visit: <http://www.nxp.com>

For sales office addresses, please send an email to: salesaddresses@nxp.com

Date of release: 21 March 2016

Document identifier: WLCSP10_PCMF_PESD2USB3X_087