

Important notice

Dear Customer,

On 7 February 2017 the former NXP Standard Product business became a new company with the tradename **Nexperia**. Nexperia is an industry leading supplier of Discrete, Logic and PowerMOS semiconductors with its focus on the automotive, industrial, computing, consumer and wearable application markets

In data sheets and application notes which still contain NXP or Philips Semiconductors references, use the references to Nexperia, as shown below.

Instead of <http://www.nxp.com>, <http://www.philips.com/> or <http://www.semiconductors.philips.com/>, use <http://www.nexperia.com>

Instead of sales.addresses@www.nxp.com or sales.addresses@www.semiconductors.philips.com, use salesaddresses@nexperia.com (email)

Replace the copyright notice at the bottom of each page or elsewhere in the document, depending on the version, as shown below:

- © NXP N.V. (year). All rights reserved or © Koninklijke Philips Electronics N.V. (year). All rights reserved

Should be replaced with:

- © **Nexperia B.V. (year). All rights reserved.**

If you have any questions related to the data sheet, please contact our nearest sales office via e-mail or telephone (details via salesaddresses@nexperia.com). Thank you for your cooperation and understanding,

Kind regards,

Team Nexperia



SOT353

Tape reel SMD; standard product orientation 12NC ending 115

Rev. 1 — 13 November 2012

Packing information

1. Packing method

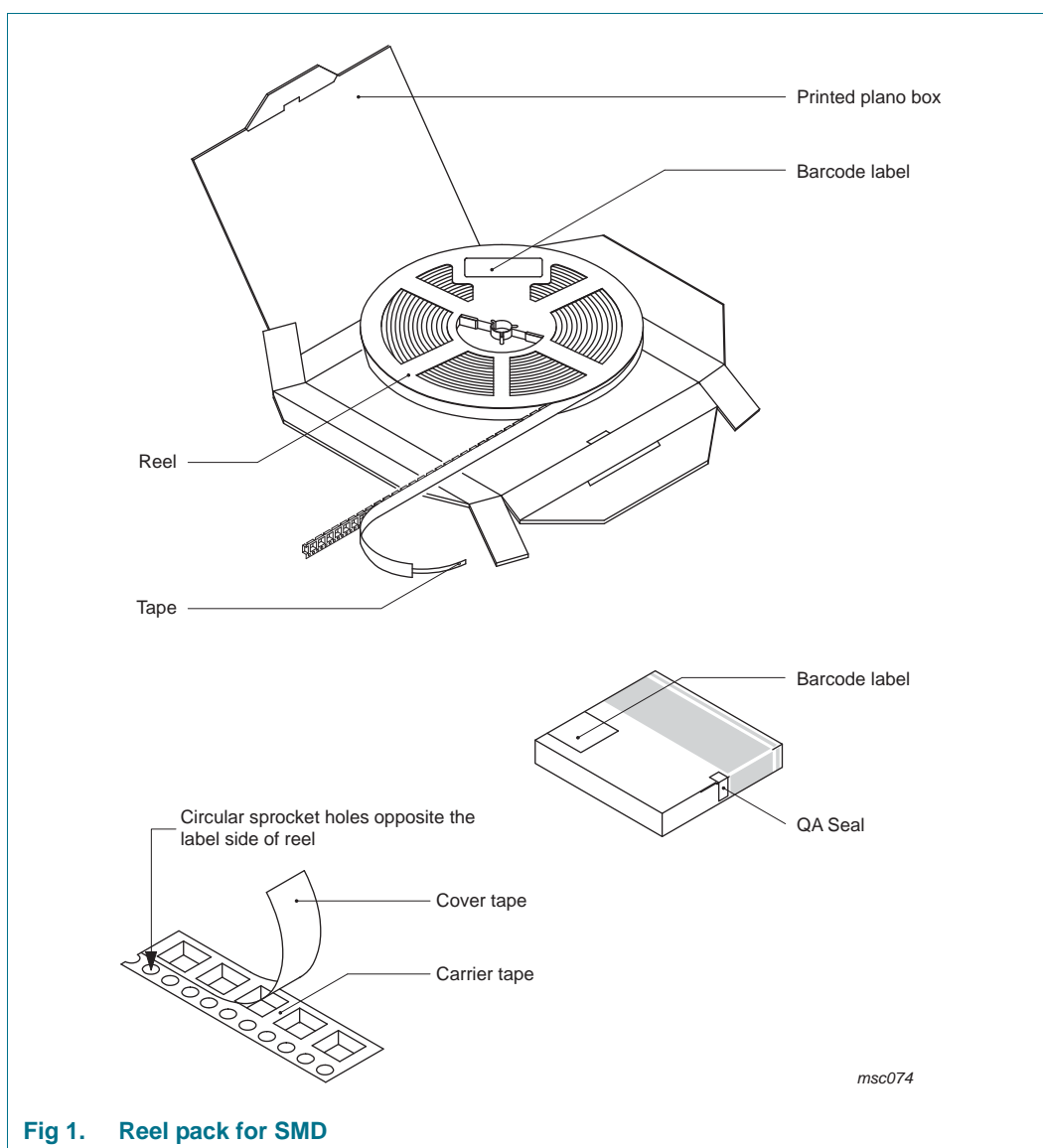
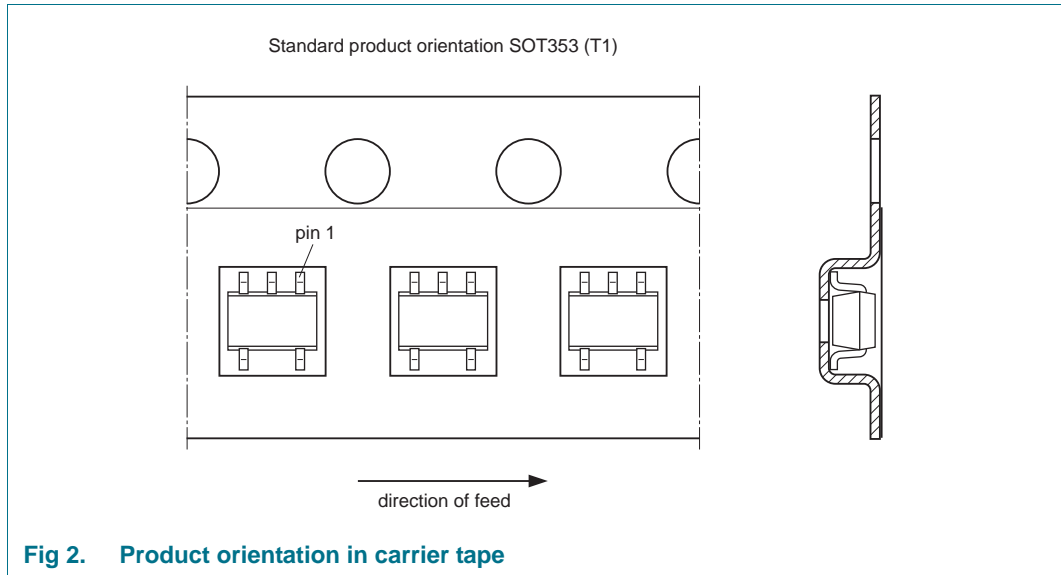

Table 1. Packing information

Package version	12NC ending	Reel dimensions d x w (mm) ^[1]	SPQ/PQ (pcs)	Reels per box	Outer box dimensions l x w x h (mm)
SOT353	115	180 x 8	3000	1	186 x 186 x 16

[1] d = reel diameter; w = tape width.

2. Product orientation



3. Carrier tape dimensions

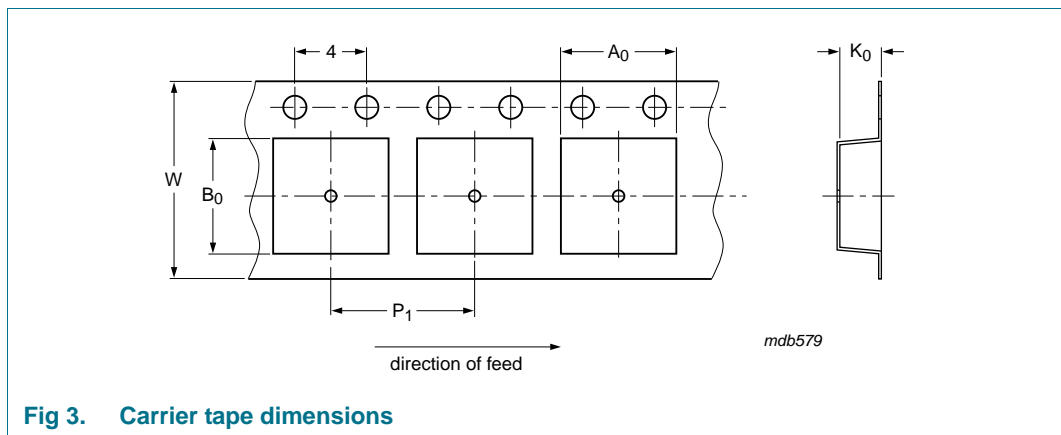

Table 2. Carrier tape dimensions

In accordance with IEC 60286-3.

A_0 (mm)	B_0 (mm)	K_0 (mm)	T (mm)	P_1 (mm)	W (mm)
2.25	2.25	1.2	-	4.0	8

Limited warranty and liability

Information in this document is believed to be accurate and reliable. However, NXP Semiconductors does not give any representations or warranties, expressed or implied, as to the accuracy or completeness of such information and shall have no liability for the consequences of use of such information.

© NXP B.V. 2012.

For more information, please visit: <http://www.nxp.com>
 For sales office addresses, please send an email to: salesaddresses@nxp.com

All rights reserved.

Date of release: 13 November 2012
 Document identifier: SOT353_115