



SOT663

plastic, surface-mounted package; 3 leads; 1 mm pitch; 1.6 mm x 1.2 mm x 0.55 mm body

30 January 2017

Package information

1. Package summary

Terminal position code	D (double)
Package type descriptive code	SOT663
Package type industry code	SOT663
Package style descriptive code	SOT (small outline transistor)
Package body material type	P (plastic)
Mounting method type	S (surface mount)
Issue date	16-3-2006
Manufacturer package code	SOT663

Table 1. Package summary

Symbol	Parameter	Min	Typ	Nom	Max	Unit
D	package length	1.5	-	1.6	1.7	mm
E	package width	1.1	-	1.2	1.3	mm
A	seated height	0.5	-	0.55	0.6	mm
e	nominal pitch	-	-	1	-	mm
n ₂	actual quantity of termination	-	-	3	-	

plastic, surface-mounted package; 3 leads; 1 mm pitch; 1.6 mm x 1.2 mm x 0.55 mm body

2. Package outline

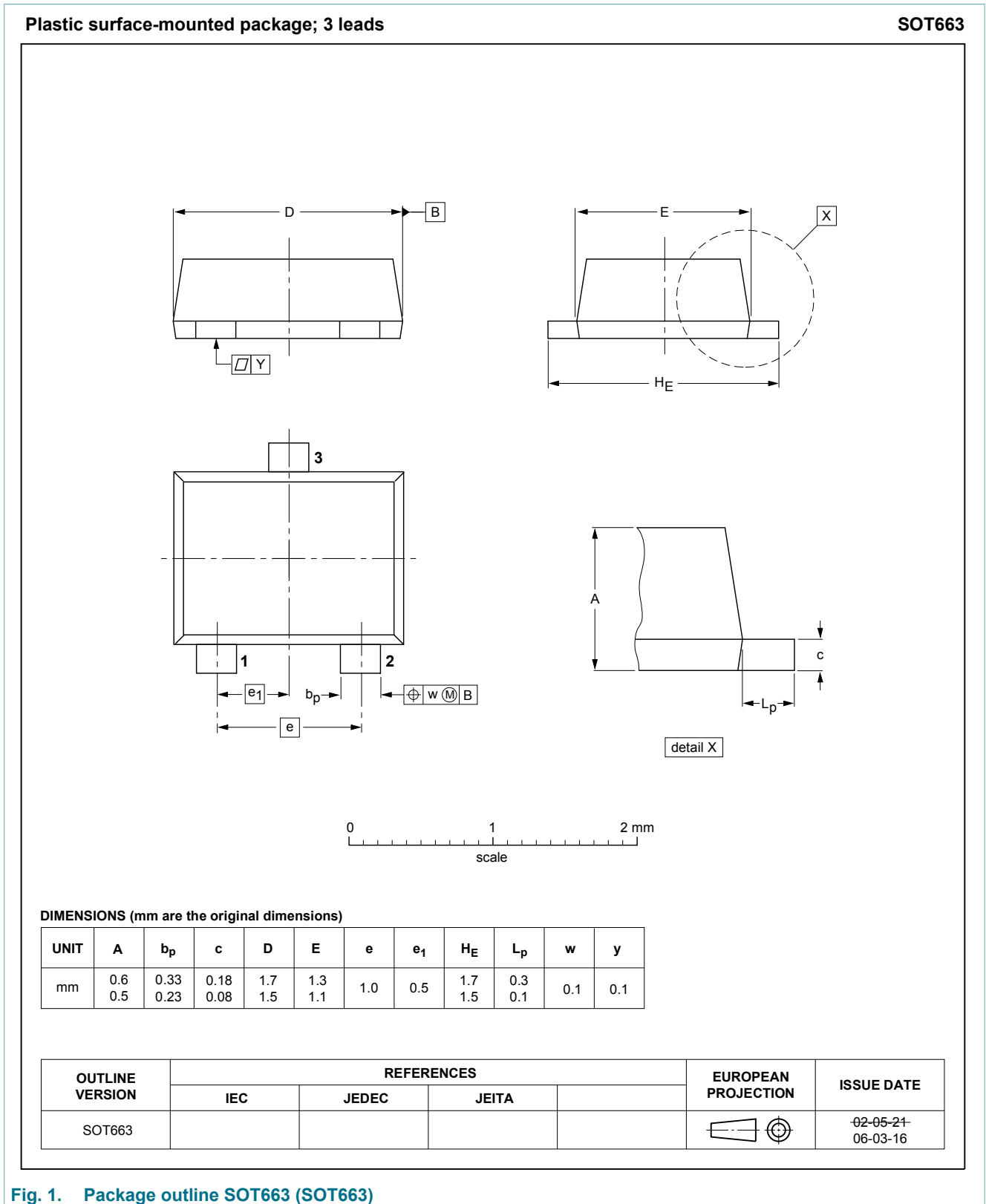

Fig. 1. Package outline SOT663 (SOT663)

plastic, surface-mounted package; 3 leads; 1 mm pitch; 1.6 mm x 1.2 mm x 0.55 mm body

3. Soldering

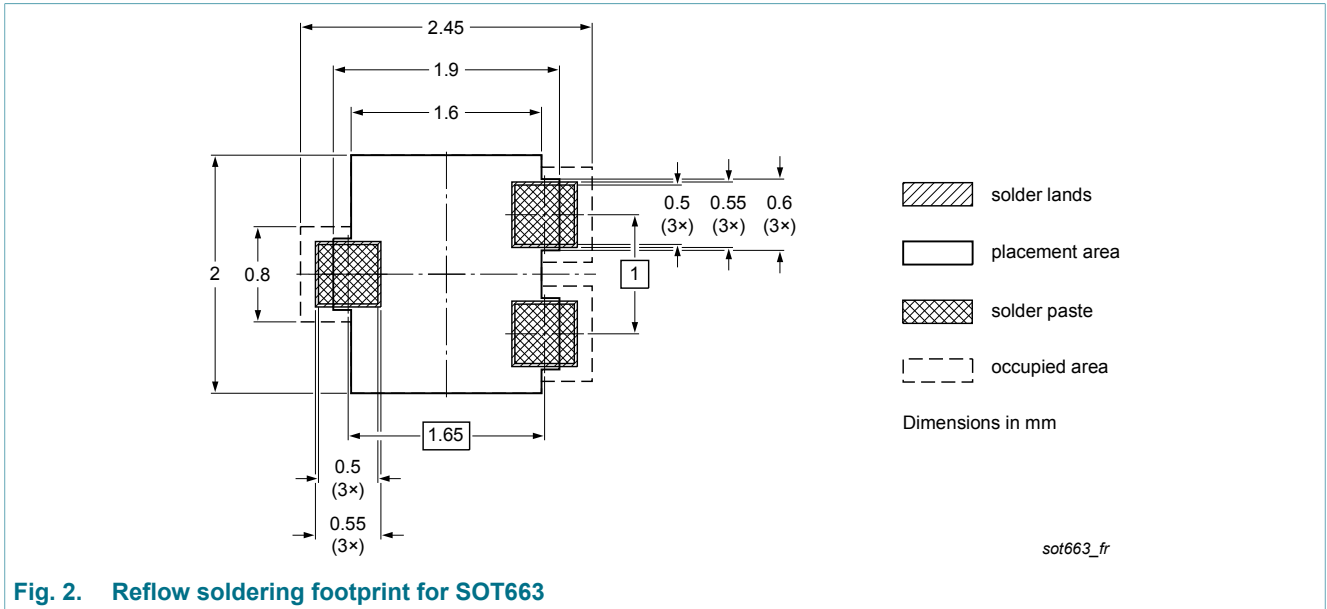

Fig. 2. Reflow soldering footprint for SOT663

4. Legal information

Disclaimers

Limited warranty and liability — Information in this document is believed to be accurate and reliable. However, Nexperia does not give any representations or warranties, expressed or implied, as to the accuracy or completeness of such information and shall have no liability for the consequences of use of such information. Nexperia takes no responsibility for the content in this document if provided by an information source outside of Nexperia.

In no event shall Nexperia be liable for any indirect, incidental, punitive, special or consequential damages (including - without limitation - lost profits, lost savings, business interruption, costs related to the removal or replacement of any products or rework charges) whether or not such damages are based on tort (including negligence), warranty, breach of contract or any other legal theory.

Notwithstanding any damages that customer might incur for any reason whatsoever, Nexperia' aggregate and cumulative liability towards customer for the products described herein shall be limited in accordance with the *Terms and conditions of commercial sale* of Nexperia.

Right to make changes — Nexperia reserves the right to make changes to information published in this document, including without limitation specifications and product descriptions, at any time and without notice. This document supersedes and replaces all information supplied prior to the publication hereof.

plastic, surface-mounted package; 3 leads; 1 mm pitch; 1.6 mm x 1.2 mm x 0.55 mm body

5. Contents

1. Package summary.....	1
2. Package outline.....	2
3. Soldering.....	3
4. Legal information.....	4

© Nexperia B.V. 2017. All rights reserved

For more information, please visit: <http://www.nexperia.com>
For sales office addresses, please send an email to: salesaddresses@nexperia.com
Date of release: 30 January 2017
