



# SMA6J series

## 600 W Transient Voltage Suppressor

5 September 2024

Product data sheet

### 1. General description

600 W uni- and bi-directional Transient Voltage Suppressor (TVS) in a SMA Surface-Mounted Device (SMD) plastic package, designed for transient voltage protection.

### 2. Features and benefits

- Rated peak pulse power at 10/1000  $\mu$ s waveform:  $P_{PPM} = 600$  W
- Reverse standoff voltage:  $V_{RWM} = 7$  V to 58 V
- Reverse current:  $I_R$  less than 1  $\mu$ A for  $V_{RWM} \geq 11$ V
- Excellent clamping capability
- Small plastic package suitable for surface-mounted design

### 3. Applications

- Power supply protection
- Power management
- Telecom, Computer, Industrial and Consumer electronics application

### 4. Quick reference data

Table 1. Quick reference data

Symbol	Parameter	Conditions		Min	Typ	Max	Unit
$V_{RWM}$	reverse standoff voltage	$T_{amb} = 25$ °C		7	-	58	V
$P_{PPM}$	rated peak pulse power	$t_p = 10/1000$ $\mu$ s; $T_{amb} = 25$ °C	[1]	-	-	600	W

[1] In accordance with IEC 61643-321 (10/1000  $\mu$ s current waveform).

## 5. Pinning information

Table 2. Pinning information

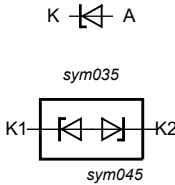
Pin	Description uni-directional	Description bi-directional	Simplified outline	Graphic symbol
1	cathode [1] [2]	cathode 1	 <p>Transparent top view SMA (SOD1001-1)</p>	 <p>K A sym035 K1 K2 sym045</p>
2	anode	cathode 2		

- [1] The marking bar indicates the cathode for uni-directional device.  
 [2] Marking bar is used for uni-directional device only.

## 6. Ordering information

Table 3. Ordering information

Type number[1]	Package		
	Name	Description	Version
SMA6J series	SMA	plastic, surface mounted package; 2 terminals; 4.30 mm x 2.65 mm x 2.10 mm body	SOD1001-1

- [1] The series consists of 58 types with reverse standoff voltages from 7 V to 58 V.

## 7. Marking

Table 4. Marking codes

Type number	Marking code	Type number	Marking code
SMA6J7.0A	BL6	SMA6J7.0CA	BQ3
SMA6J7.5A	BL7	SMA6J7.5CA	BQ4
SMA6J8.0A	BL8	SMA6J8.0CA	BQ5
SMA6J8.5A	BL9	SMA6J8.5CA	BQ6
SMA6J9.0A	BM2	SMA6J9.0CA	BQ7
SMA6J10A	BM3	SMA6J10CA	BQ8
SMA6J11A	BM4	SMA6J11CA	BQ9
SMA6J12A	BM5	SMA6J12CA	BR2
SMA6J13A	BM6	SMA6J13CA	BR3
SMA6J14A	BM7	SMA6J14CA	BR4
SMA6J15A	BM8	SMA6J15CA	BR5
SMA6J16A	BM9	SMA6J16CA	BR6
SMA6J17A	BN2	SMA6J17CA	BR7
SMA6J18A	BN3	SMA6J18CA	BR8
SMA6J20A	BN4	SMA6J20CA	BR9
SMA6J22A	BN5	SMA6J22CA	BS2
SMA6J24A	BN6	SMA6J24CA	BS3
SMA6J26A	BN7	SMA6J26CA	BS4
SMA6J28A	BN8	SMA6J28CA	BS5

Type number	Marking code	Type number	Marking code
SMA6J30A	BN9	SMA6J30CA	BS6
SMA6J33A	BP2	SMA6J33CA	BS7
SMA6J36A	BP3	SMA6J36CA	BS8
SMA6J40A	BP4	SMA6J40CA	BS9
SMA6J43A	BP5	SMA6J43CA	BT2
SMA6J45A	BP6	SMA6J45CA	BT3
SMA6J48A	BP7	SMA6J48CA	BT4
SMA6J51A	BP8	SMA6J51CA	BT5
SMA6J54A	BP9	SMA6J54CA	BT6
SMA6J58A	BQ2	SMA6J58CA	BT7

## 8. Limiting values

**Table 5. Limiting values**

In accordance with the Absolute Maximum Rating System (IEC 60134).

Symbol	Parameter	Conditions		Min	Max	Unit
<b>Per diode</b>						
$P_{PPM}$	rated peak pulse power	$t_p = 10/1000 \mu s$	[1]	-	600	W
$I_{PPM}$	rated peak pulse current	$t_p = 10/1000 \mu s$	[1]	-	see table 8	A
$T_j$	junction temperature			-	150	°C
$T_{amb}$	ambient temperature			-55	150	°C
$T_{stg}$	storage temperature			-55	150	°C

[1] In accordance with IEC 61643-321 (10/1000  $\mu s$  current waveform).

**Table 6. ESD maximum ratings**

Symbol	Parameter	Conditions		Min	Max	Unit
<b>Per diode</b>						
$V_{ESD}$	electrostatic discharge voltage	IEC 61000-4-2; contact discharge; $T_{amb} = 25^\circ C$	[1]	-	30	kV

[1] Device stressed with ten non-repetitive ESD pulses.

**Table 7. ESD standards compliance**

Standard	
<b>Per diode</b>	
IEC 61000-4-2; level 4 (ESD)	> 15 kV (air); > 8 kV (contact)
MIL-STD-883; class 3 (human body model)	> 4kV

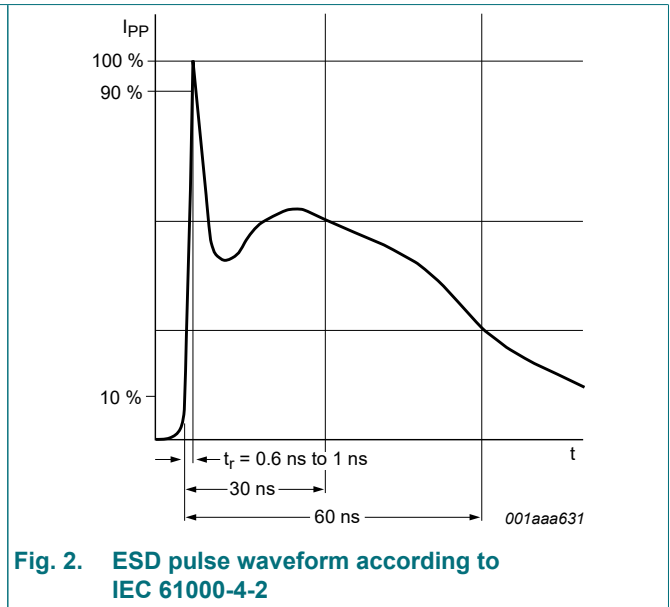
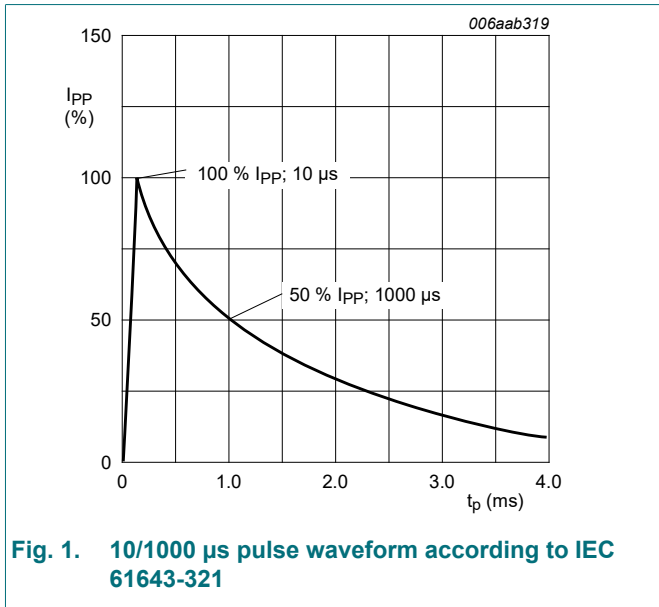

## 9. Characteristics

**Table 8. Characteristics per type;**

$T_{amb} = 25^{\circ}\text{C}$  unless otherwise specified.

Type number		Reverse standoff voltage $V_{RWM}$ (V)	Breakdown voltage $V_{BR}$ (V) at test current $I_T$			Reverse leakage current $I_{RM}$ at $V_{RWM}$ ( $\mu\text{A}$ ) [1]	Test current $I_T$ (mA)	Clamping voltage $V_{CL}$ (V)	
uni-directional	bi-directional		Max	Min	Typ			Max	Max
SMA6J7.0A	SMA6J7.0CA	7.0	7.78	8.19	8.60	200/400	10	12.0	50
SMA6J7.5A	SMA6J7.5CA	7.5	8.33	8.77	9.21	100/200	1	12.9	46.6
SMA6J8.0A	SMA6J8.0CA	8.0	8.89	9.36	9.83	50/100	1	13.6	44.2
SMA6J8.5A	SMA6J8.5CA	8.5	9.44	9.92	10.40	20/40	1	14.4	41.7
SMA6J9.0A	SMA6J9.0CA	9.0	10.00	10.55	11.10	10/20	1	15.4	39
SMA6J10A	SMA6J10CA	10	11.10	11.70	12.30	5/10	1	17.0	37
SMA6J11A	SMA6J11CA	11	12.20	12.85	13.50	1	1	18.2	33
SMA6J12A	SMA6J12CA	12	13.30	14.00	14.70	1	1	19.9	31
SMA6J13A	SMA6J13CA	13	14.40	15.15	15.90	1	1	21.5	29
SMA6J14A	SMA6J14CA	14	15.60	16.40	17.20	1	1	23.2	25.9
SMA6J15A	SMA6J15CA	15	16.70	17.60	18.50	1	1	24.4	25.1
SMA6J16A	SMA6J16CA	16	17.80	18.75	19.70	1	1	26.0	23.1
SMA6J17A	SMA6J17CA	17	18.90	19.90	20.90	1	1	27.6	22.6
SMA6J18A	SMA6J18CA	18	20.00	21.05	22.10	1	1	29.2	21.5
SMA6J20A	SMA6J20CA	20	22.20	23.35	24.50	1	1	32.4	19.4
SMA6J22A	SMA6J22CA	22	24.40	25.65	26.90	1	1	35.5	17
SMA6J24A	SMA6J24CA	24	26.70	28.10	29.50	1	1	38.9	16
SMA6J26A	SMA6J26CA	26	28.90	30.40	31.90	1	1	42.1	14.9
SMA6J28A	SMA6J28CA	28	31.10	32.75	34.40	1	1	45.4	13.8
SMA6J30A	SMA6J30CA	30	33.30	35.05	36.80	1	1	48.4	12.5
SMA6J33A	SMA6J33CA	33	36.70	38.65	40.60	1	1	53.3	11.8
SMA6J36A	SMA6J36CA	36	40.00	42.10	44.20	1	1	58.1	10.4
SMA6J40A	SMA6J40CA	40	44.40	46.75	49.10	1	1	64.5	9.7
SMA6J43A	SMA6J43CA	43	47.80	50.30	52.80	1	1	69.4	8.7
SMA6J45A	SMA6J45CA	45	50.00	52.65	55.30	1	1	72.7	8.3
SMA6J48A	SMA6J48CA	48	53.30	56.10	58.90	1	1	77.4	8.1
SMA6J51A	SMA6J51CA	51	56.70	59.70	62.70	1	1	82.4	7.4
SMA6J54A	SMA6J54CA	54	60.00	63.15	66.30	1	1	87.1	6.9
SMA6J58A	SMA6J58CA	58	64.40	67.80	71.20	1	1	93.6	6.7

[1]  $I_{RM}$  Max. is doubled for bi-directional type with  $V_{RWM} \leq 10$  V

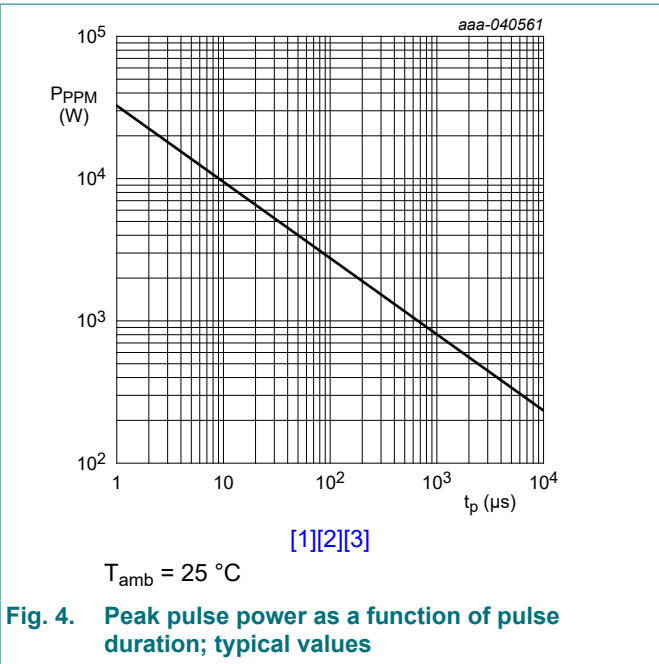
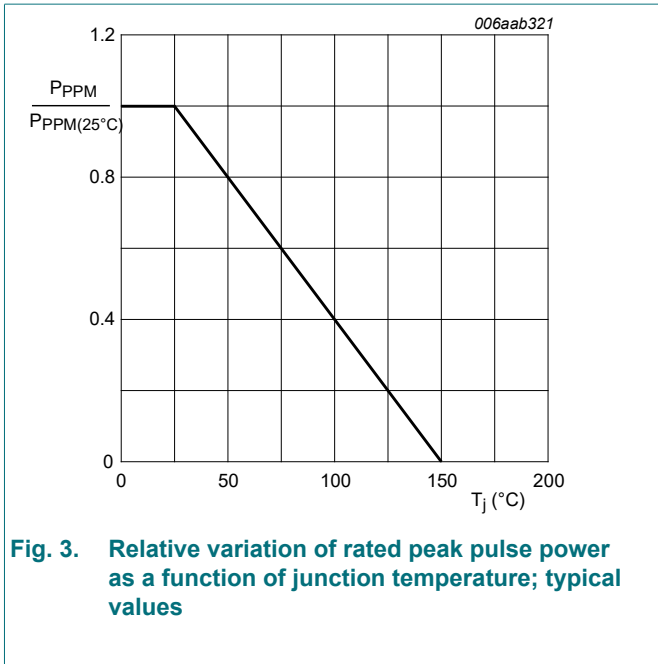

- [1] Peak pulse power derating curve derived from typical measured values using 8/20 μs and 10/1000 μs waveforms.
- [2] In accordance with IEC 61000-4-5 (8/20 μs waveforms).
- [3] In accordance with IEC 61643-321 (10/1000 μs waveforms).

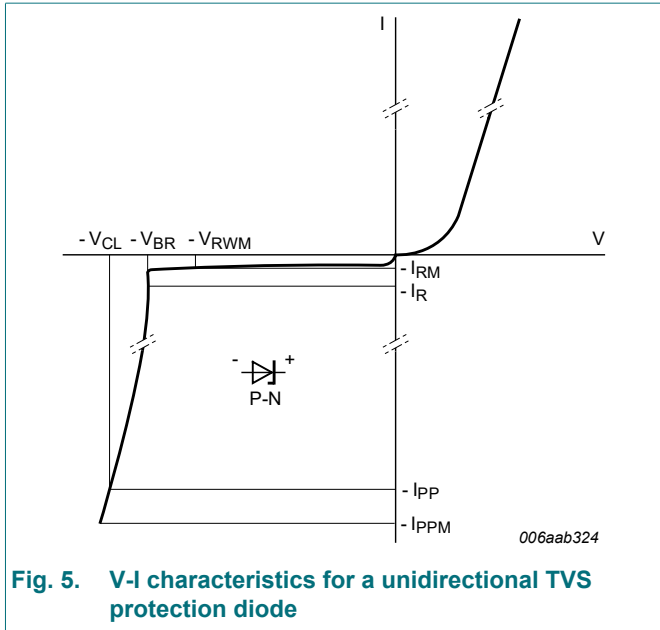

Fig. 5. V-I characteristics for a unidirectional TVS protection diode

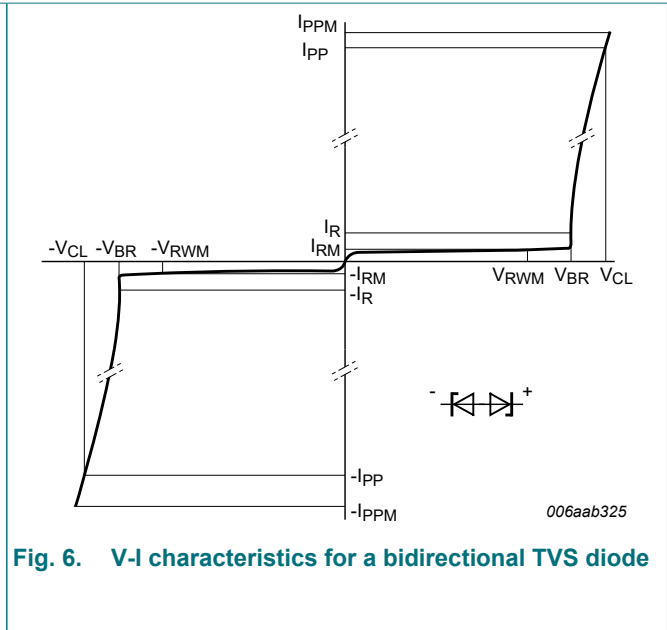

Fig. 6. V-I characteristics for a bidirectional TVS diode

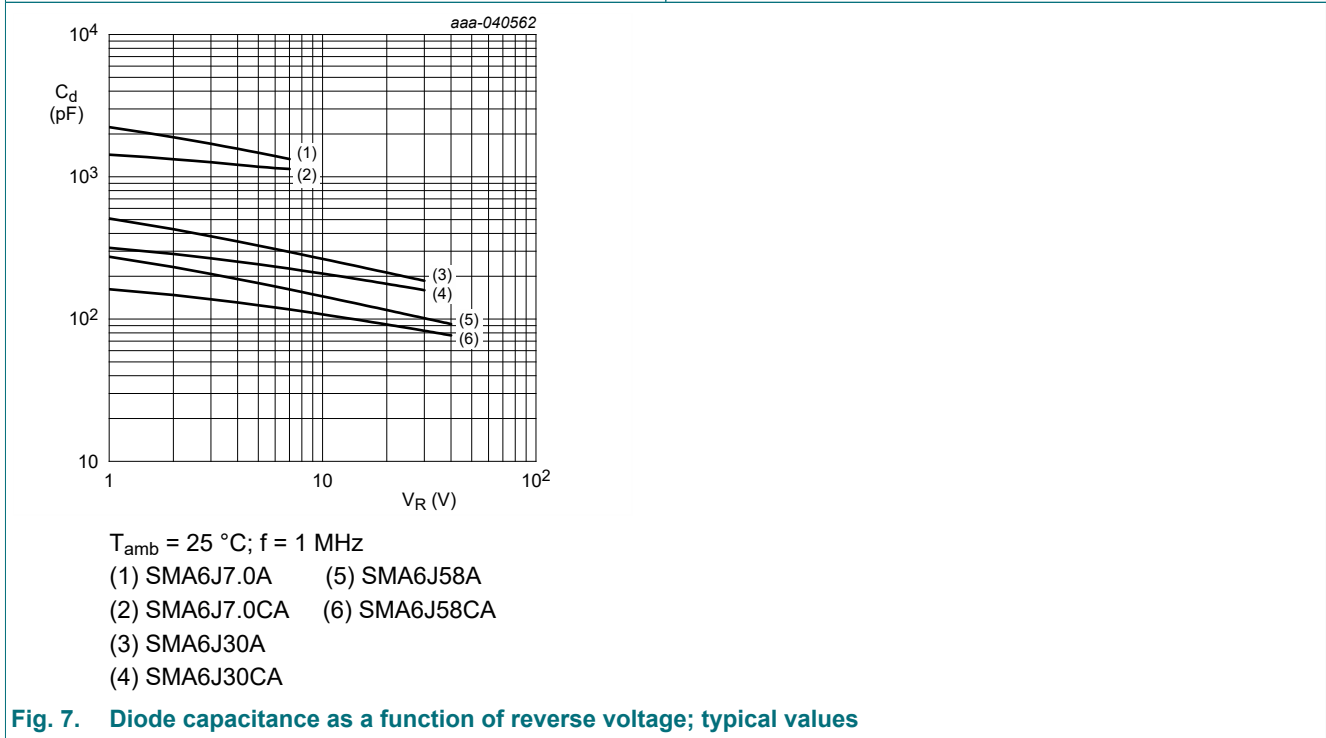
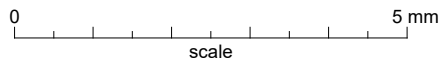
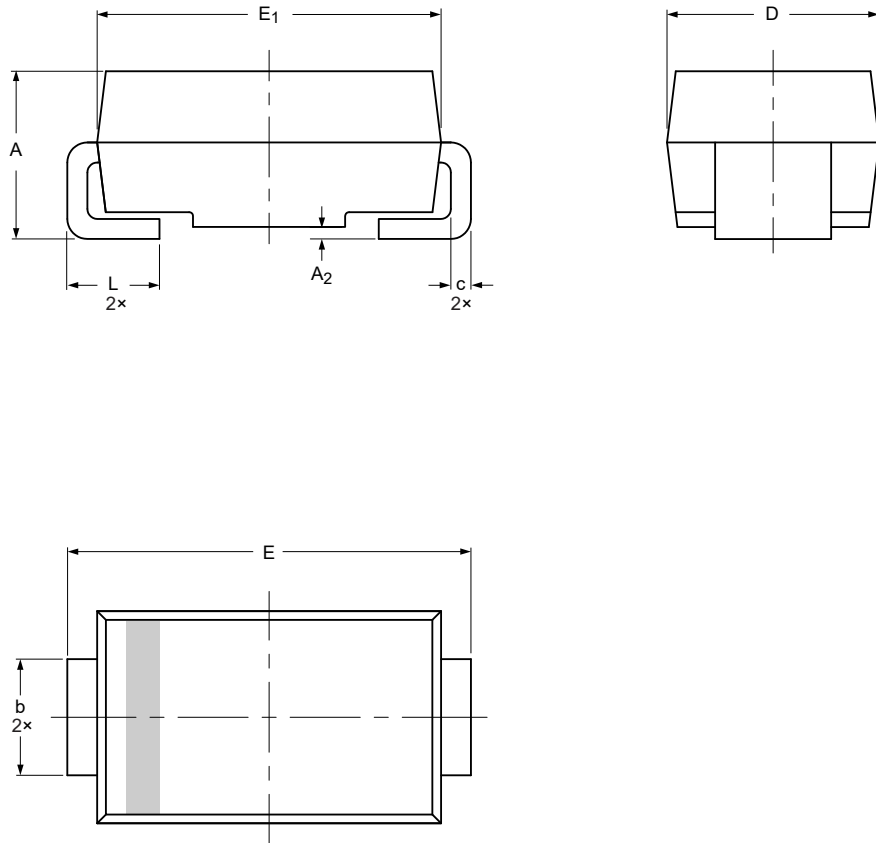

Fig. 7. Diode capacitance as a function of reverse voltage; typical values

### 10. Package outline

SMA: plastic, surface mounted package; 2 terminals; 4.30 mm x 2.65 mm x 2.10 mm body

SOD1001-1



Dimensions (mm are the original dimensions)

Unit <sup>(1)</sup>	A	A <sub>2</sub>	b	c	D	E	E <sub>1</sub>	L
max	2.45	0.20	1.65	0.36	2.92	5.59	4.60	1.52
mm nom								
min	1.95	0.05	1.25	0.15	2.40	4.80	3.95	0.75

sod1001-1\_po

Outline version	References			European projection	Issue date
	IEC	JEDEC	JEITA		
SOD1001-1					24-05-22

Fig. 8. Package outline SMA (SOD1001-1)



# 11. Soldering

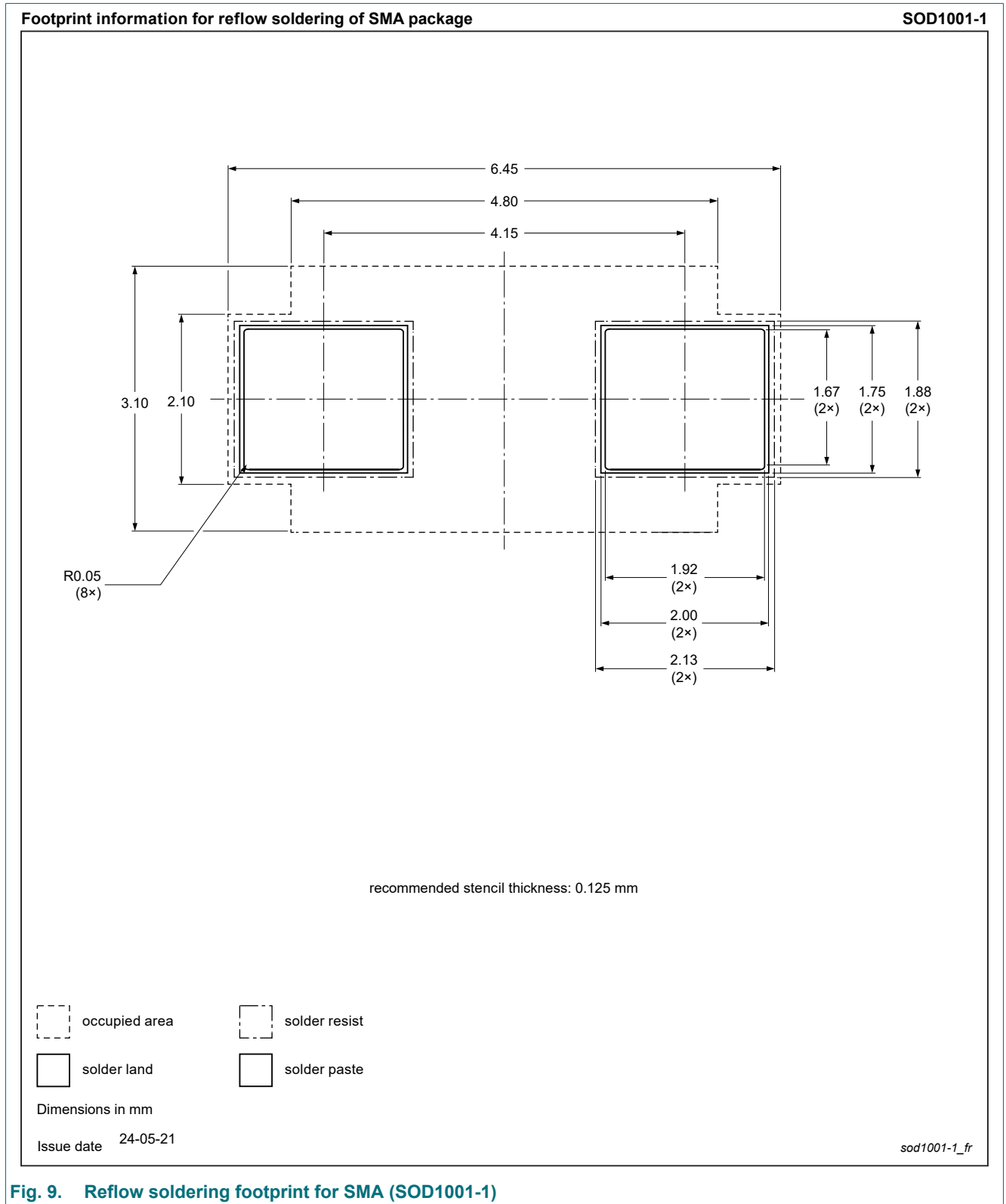

**Fig. 9. Reflow soldering footprint for SMA (SOD1001-1)**

## 12. Revision history

Table 9. Revision history

Data sheet ID	Release date	Data sheet status	Change notice	Supersedes
SMA6J_SER v.1	20240905	Product data sheet	-	-

## 13. Legal information

### Data sheet status

Document status [1][2]	Product status [3]	Definition
Objective [short] data sheet	Development	This document contains data from the objective specification for product development.
Preliminary [short] data sheet	Qualification	This document contains data from the preliminary specification.
Product [short] data sheet	Production	This document contains the product specification.

- [1] Please consult the most recently issued document before initiating or completing a design.
- [2] The term 'short data sheet' is explained in section "Definitions".
- [3] The product status of device(s) described in this document may have changed since this document was published and may differ in case of multiple devices. The latest product status information is available on the internet at <https://www.nexperia.com>.

### Definitions

**Draft** — The document is a draft version only. The content is still under internal review and subject to formal approval, which may result in modifications or additions. Nexperia does not give any representations or warranties as to the accuracy or completeness of information included herein and shall have no liability for the consequences of use of such information.

**Short data sheet** — A short data sheet is an extract from a full data sheet with the same product type number(s) and title. A short data sheet is intended for quick reference only and should not be relied upon to contain detailed and full information. For detailed and full information see the relevant full data sheet, which is available on request via the local Nexperia sales office. In case of any inconsistency or conflict with the short data sheet, the full data sheet shall prevail.

**Product specification** — The information and data provided in a Product data sheet shall define the specification of the product as agreed between Nexperia and its customer, unless Nexperia and customer have explicitly agreed otherwise in writing. In no event however, shall an agreement be valid in which the Nexperia product is deemed to offer functions and qualities beyond those described in the Product data sheet.

### Disclaimers

**Limited warranty and liability** — Information in this document is believed to be accurate and reliable. However, Nexperia does not give any representations or warranties, expressed or implied, as to the accuracy or completeness of such information and shall have no liability for the consequences of use of such information. Nexperia takes no responsibility for the content in this document if provided by an information source outside of Nexperia.

In no event shall Nexperia be liable for any indirect, incidental, punitive, special or consequential damages (including - without limitation - lost profits, lost savings, business interruption, costs related to the removal or replacement of any products or rework charges) whether or not such damages are based on tort (including negligence), warranty, breach of contract or any other legal theory.

Notwithstanding any damages that customer might incur for any reason whatsoever, Nexperia's aggregate and cumulative liability towards customer for the products described herein shall be limited in accordance with the Terms and conditions of commercial sale of Nexperia.

**Right to make changes** — Nexperia reserves the right to make changes to information published in this document, including without limitation specifications and product descriptions, at any time and without notice. This document supersedes and replaces all information supplied prior to the publication hereof.

**Suitability for use** — Nexperia products are not designed, authorized or warranted to be suitable for use in life support, life-critical or safety-critical systems or equipment, nor in applications where failure or malfunction of an Nexperia product can reasonably be expected to result in personal

injury, death or severe property or environmental damage. Nexperia and its suppliers accept no liability for inclusion and/or use of Nexperia products in such equipment or applications and therefore such inclusion and/or use is at the customer's own risk.

**Quick reference data** — The Quick reference data is an extract of the product data given in the Limiting values and Characteristics sections of this document, and as such is not complete, exhaustive or legally binding.

**Applications** — Applications that are described herein for any of these products are for illustrative purposes only. Nexperia makes no representation or warranty that such applications will be suitable for the specified use without further testing or modification.

Customers are responsible for the design and operation of their applications and products using Nexperia products, and Nexperia accepts no liability for any assistance with applications or customer product design. It is customer's sole responsibility to determine whether the Nexperia product is suitable and fit for the customer's applications and products planned, as well as for the planned application and use of customer's third party customer(s). Customers should provide appropriate design and operating safeguards to minimize the risks associated with their applications and products.

Nexperia does not accept any liability related to any default, damage, costs or problem which is based on any weakness or default in the customer's applications or products, or the application or use by customer's third party customer(s). Customer is responsible for doing all necessary testing for the customer's applications and products using Nexperia products in order to avoid a default of the applications and the products or of the application or use by customer's third party customer(s). Nexperia does not accept any liability in this respect.

**Limiting values** — Stress above one or more limiting values (as defined in the Absolute Maximum Ratings System of IEC 60134) will cause permanent damage to the device. Limiting values are stress ratings only and (proper) operation of the device at these or any other conditions above those given in the Recommended operating conditions section (if present) or the Characteristics sections of this document is not warranted. Constant or repeated exposure to limiting values will permanently and irreversibly affect the quality and reliability of the device.

**Terms and conditions of commercial sale** — Nexperia products are sold subject to the general terms and conditions of commercial sale, as published at <http://www.nexperia.com/profile/terms>, unless otherwise agreed in a valid written individual agreement. In case an individual agreement is concluded only the terms and conditions of the respective agreement shall apply. Nexperia hereby expressly objects to applying the customer's general terms and conditions with regard to the purchase of Nexperia products by customer.

**No offer to sell or license** — Nothing in this document may be interpreted or construed as an offer to sell products that is open for acceptance or the grant, conveyance or implication of any license under any copyrights, patents or other industrial or intellectual property rights.

**Export control** — This document as well as the item(s) described herein may be subject to export control regulations. Export might require a prior authorization from competent authorities.

**Non-automotive qualified products** — Unless this data sheet expressly states that this specific Nexperia product is automotive qualified, the product is not suitable for automotive use. It is neither qualified nor tested in accordance with automotive testing or application requirements. Nexperia accepts no liability for inclusion and/or use of non-automotive qualified products in automotive equipment or applications.

In the event that customer uses the product for design-in and use in automotive applications to automotive specifications and standards, customer (a) shall use the product without Nexperia's warranty of the product for such automotive applications, use and specifications, and (b) whenever customer uses the product for automotive applications beyond Nexperia's specifications such use shall be solely at customer's own risk, and (c) customer fully indemnifies Nexperia for any liability, damages or failed product claims resulting from customer design and use of the product for automotive applications beyond Nexperia's standard warranty and Nexperia's product specifications.

**Translations** — A non-English (translated) version of a document is for reference only. The English version shall prevail in case of any discrepancy between the translated and English versions.

### Trademarks

Notice: All referenced brands, product names, service names and trademarks are the property of their respective owners.

## Contents

---

1. General description.....	1
2. Features and benefits.....	1
3. Applications.....	1
4. Quick reference data.....	1
5. Pinning information.....	2
6. Ordering information.....	2
7. Marking.....	2
8. Limiting values.....	4
9. Characteristics.....	5
10. Package outline.....	8
11. Soldering.....	9
12. Revision history.....	10
13. Legal information.....	11

---

© Nexperia B.V. 2024. All rights reserved

For more information, please visit: <http://www.nexperia.com>

For sales office addresses, please send an email to: [salesaddresses@nexperia.com](mailto:salesaddresses@nexperia.com)

Date of release: 5 September 2024

---