



PSC1065H

650 V, 10 A SiC Schottky diode in DPAK R2P

8 February 2024

Product data sheet

1. General description

Nexperia introduces leading edge Silicon Carbide (SiC) Schottky diode for ultra high performance, low loss, high efficiency power conversion applications. The SiC Schottky diode encapsulated in a Real-2-Pin R2P (TO-252-2) Surface-Mounted Device (SMD) power plastic package offers temperature independent capacitive turn-off, zero recovery switching behavior combined with an outstanding figure-of-merit ($Q_C \times V_F$). The Merged PiN Schottky (MPS) diode improves the robustness expressed in a high I_{FSM} .

2. Features and benefits

- Zero forward and reverse recovery
- Temperature independent fast and smooth switching performance
- Outstanding figure-of-merit ($Q_C \times V_F$)
- High I_{FSM} capability
- High power density
- Reduced system cost
- System miniaturization
- Reduced EMI

3. Applications

- Switch Mode Power Supply (SMPS)
- AC-DC and DC-DC converter
- Battery charging infrastructure
- Server and telecom power supply
- Uninterruptible Power Supply (UPS)
- Photovoltaic inverters

4. Quick reference data

Table 1. Quick reference data

Symbol	Parameter	Conditions	Min	Typ	Max	Unit
V_{DC}	DC blocking voltage		650	-	-	V
I_F	forward current	$T_c \leq 122\text{ °C}$; $\delta = 1$	-	-	10	A
Q_C	total capacitive charge	$V_R = 400\text{ V}$; $di_F/dt = 200\text{ A}/\mu\text{s}$; $I_F = 10\text{ A}$; $T_j = 25\text{ °C}$	-	22	-	nC

5. Pinning information

Table 2. Pinning information

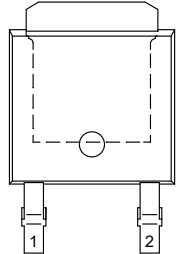
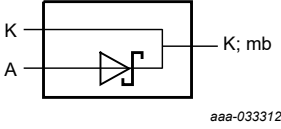
Pin	Symbol	Description	Simplified outline	Graphic symbol
1	K	cathode	 <p>DPAK R2P (SOT8017)</p>	 <p>aaa-033312</p>
2	A	anode		
mb	K	mounting base; connected to cathode		

6. Ordering information

Table 3. Ordering information

Type number	Package		
	Name	Description	Version
PSC1065H	DPAK R2P	Plastic, single-ended surface-mounted package (DPAK R2P); Real-2-Pin configuration; 4.58 mm pitch; 6.16 mm x 6.54 mm x 2.29 mm body	SOT8017

7. Marking

Table 4. Marking codes

Type number	Marking code
PSC1065H	PSC1065H

8. Limiting values

Table 5. Limiting values

In accordance with the Absolute Maximum Rating System (IEC 60134).

Symbol	Parameter	Conditions	Min	Max	Unit
V_{RRM}	repetitive peak reverse voltage		-	650	V
dv/dt	diode dv/dt ruggedness	$0\text{ V} \leq V_R \leq 480\text{ V}$	-	100	V/ns
I_F	forward current	$T_c \leq 122\text{ }^\circ\text{C}$; $\delta = 1$	-	10	A
I_{FSM}	non-repetitive peak forward current	$t_p = 10\text{ }\mu\text{s}$; square wave; $T_c = 25\text{ }^\circ\text{C}$	-	440	A
		$t_p = 10\text{ ms}$; half sine-wave; $T_c = 25\text{ }^\circ\text{C}$	-	52	A
		$t_p = 10\text{ ms}$; half sine-wave; $T_c = 150\text{ }^\circ\text{C}$	-	42	A
$\int i^2 dt$	$i^2 t$ value	$t_p = 10\text{ ms}$; $T_c = 25\text{ }^\circ\text{C}$	-	14	A ² s
		$t_p = 10\text{ ms}$; $T_c = 150\text{ }^\circ\text{C}$	-	9	A ² s
P_{tot}	total power dissipation	$T_c \leq 25\text{ }^\circ\text{C}$	-	58	W
T_j	junction temperature		-	175	$^\circ\text{C}$
T_{amb}	ambient temperature		-55	175	$^\circ\text{C}$
T_{stg}	storage temperature		-65	175	$^\circ\text{C}$

9. Thermal characteristics

Table 6. Thermal characteristics

Symbol	Parameter	Conditions	Min	Typ	Max	Unit
$R_{th(j-c)}$	thermal resistance from junction to case		-	2	2.6	K/W

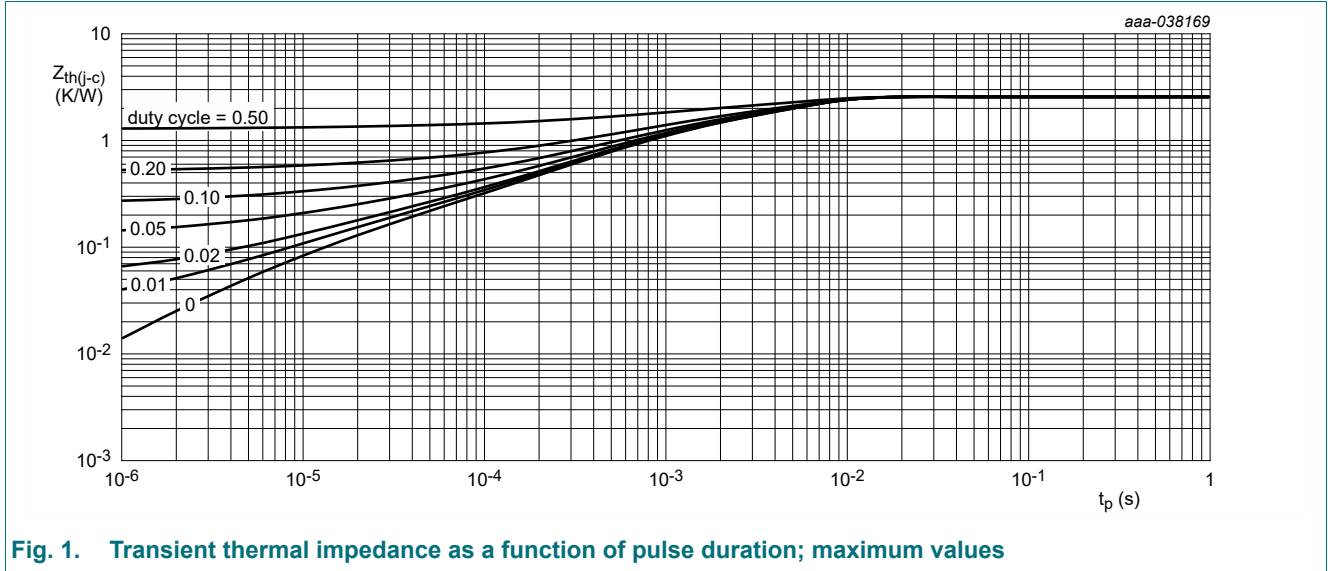

Fig. 1. Transient thermal impedance as a function of pulse duration; maximum values

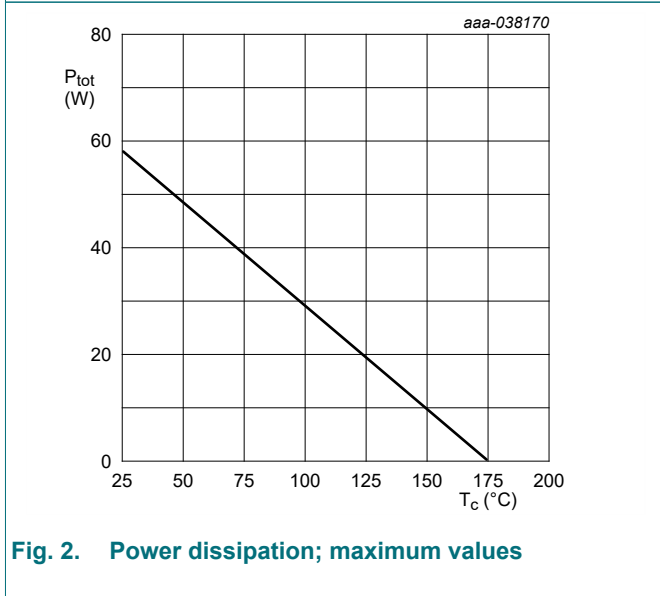

Fig. 2. Power dissipation; maximum values

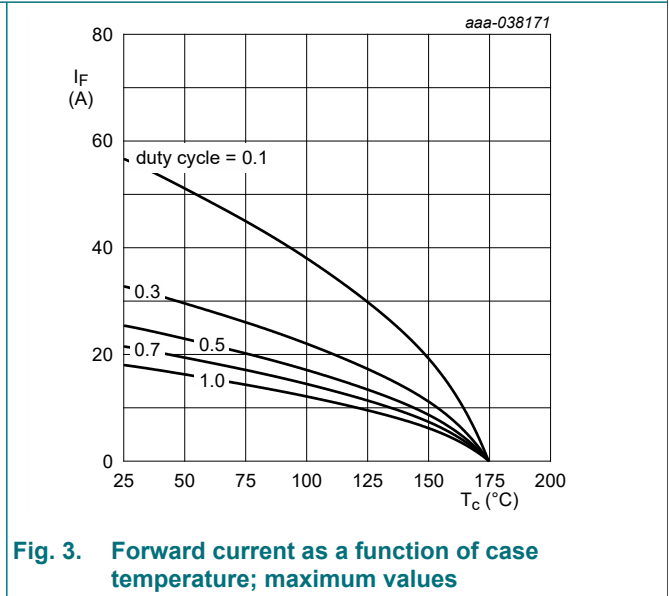
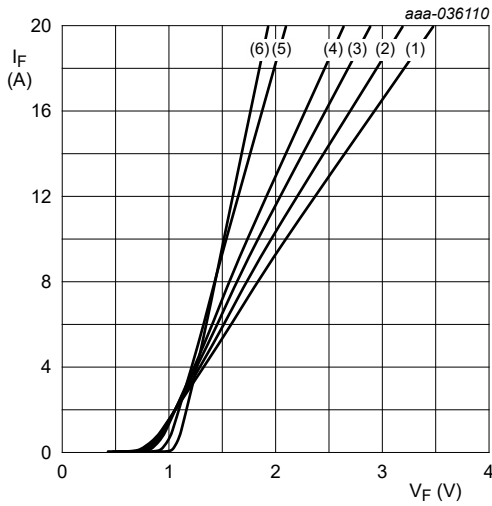

Fig. 3. Forward current as a function of case temperature; maximum values

10. Characteristics

Table 7. Characteristics

Symbol	Parameter	Conditions	Min	Typ	Max	Unit
V_{DC}	DC blocking voltage		650	-	-	V
V_F	forward voltage	$I_F = 10\text{ A}; T_j = 25\text{ °C}$	-	1.5	1.8	V
		$I_F = 10\text{ A}; T_j = 150\text{ °C}$	-	1.95	2.6	V
I_R	reverse current	$V_R = 650\text{ V}; T_j = 25\text{ °C}$	-	1	60	μA
		$V_R = 650\text{ V}; T_j = 150\text{ °C}$	-	10	120	μA
C_d	diode capacitance	$V_R = 1\text{ V}; f = 1\text{ MHz}; T_j = 25\text{ °C}$	-	340	-	pF
		$V_R = 400\text{ V}; f = 1\text{ MHz}; T_j = 25\text{ °C}$	-	36	-	pF
Q_C	total capacitive charge	$V_R = 400\text{ V}; dI_F/dt = 200\text{ A}/\mu\text{s}; I_F = 10\text{ A}; T_j = 25\text{ °C}$	-	22	-	nC



Pulsed condition:

- (1) $T_j = 175\text{ °C}$
- (2) $T_j = 150\text{ °C}$
- (3) $T_j = 125\text{ °C}$
- (4) $T_j = 100\text{ °C}$
- (5) $T_j = 25\text{ °C}$
- (6) $T_j = -55\text{ °C}$

Fig. 4. Forward current as a function of forward voltage; typical values

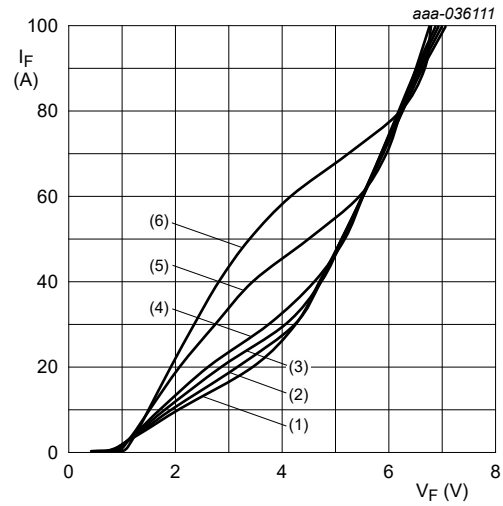

Pulsed condition:

- (1) $T_j = 175\text{ °C}$
- (2) $T_j = 150\text{ °C}$
- (3) $T_j = 125\text{ °C}$
- (4) $T_j = 100\text{ °C}$
- (5) $T_j = 25\text{ °C}$
- (6) $T_j = -55\text{ °C}$

Fig. 5. Forward characteristics in surge current as a function of forward voltage; typical values

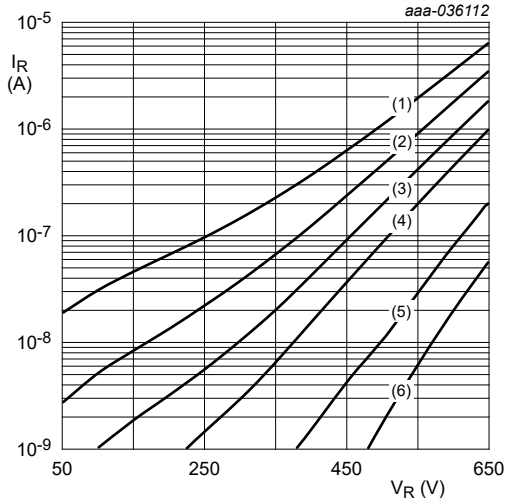

Pulsed condition:

- (1) $T_j = 175\text{ °C}$
- (2) $T_j = 150\text{ °C}$
- (3) $T_j = 125\text{ °C}$
- (4) $T_j = 100\text{ °C}$
- (5) $T_j = 25\text{ °C}$
- (6) $T_j = -55\text{ °C}$

Fig. 6. Reverse current as a function of reverse voltage; typical values

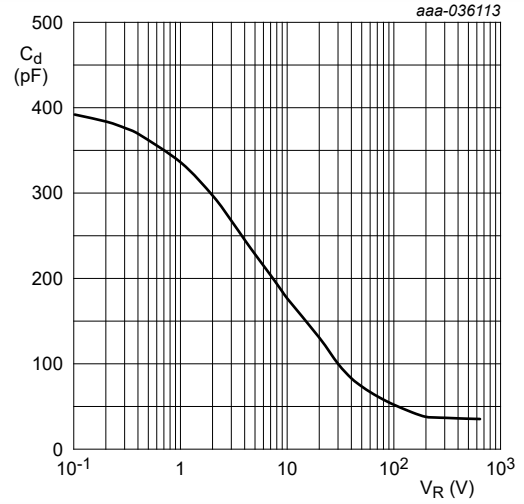

$f = 1\text{ MHz}; T_{amb} = 25\text{ °C}$

Fig. 7. Diode capacitance as a function of reverse voltage; typical values

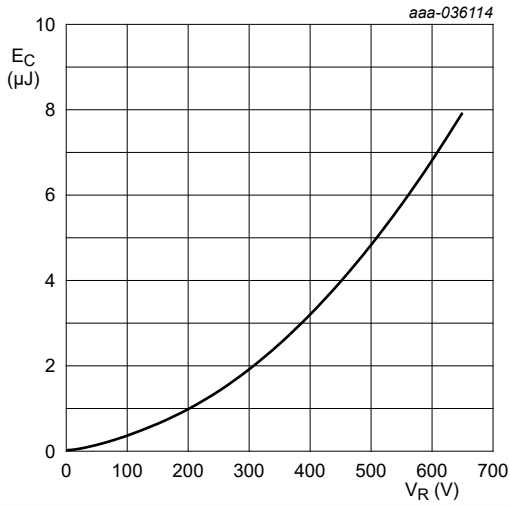

Fig. 8. Capacitance stored energy as a function of reverse voltage; typical values

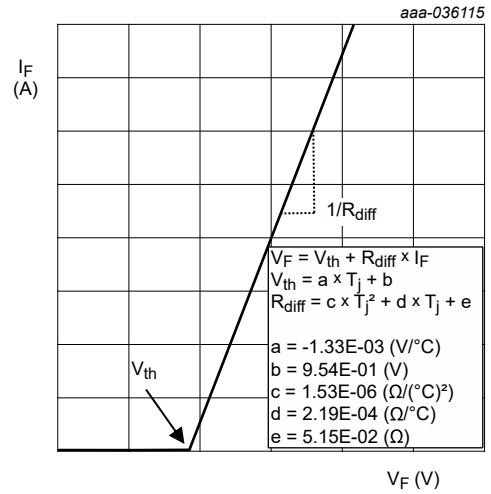
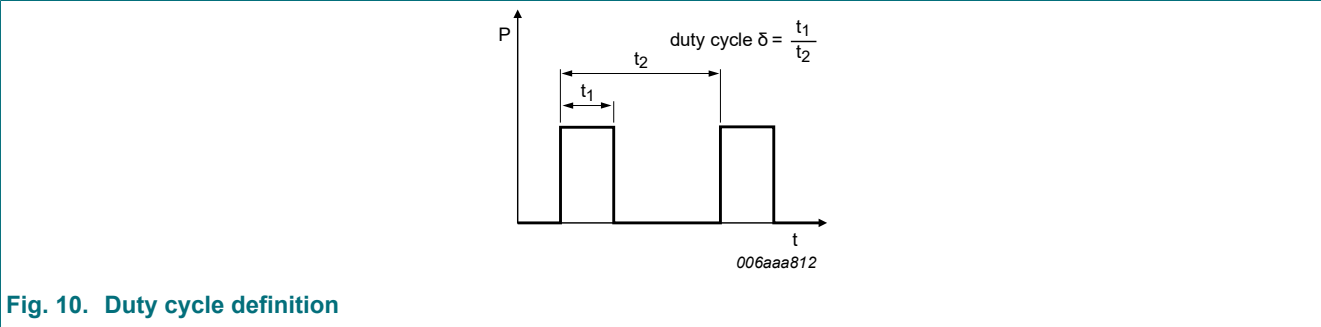

Fig. 9. Simplified forward characteristics mode

11. Test information



12. Package outline

Plastic, single-ended surface-mounted package (DPAK R2P); Real-2-Pin configuration;
4.58 mm pitch; 6.16 mm x 6.54 mm x 2.29 mm body

SOT8017

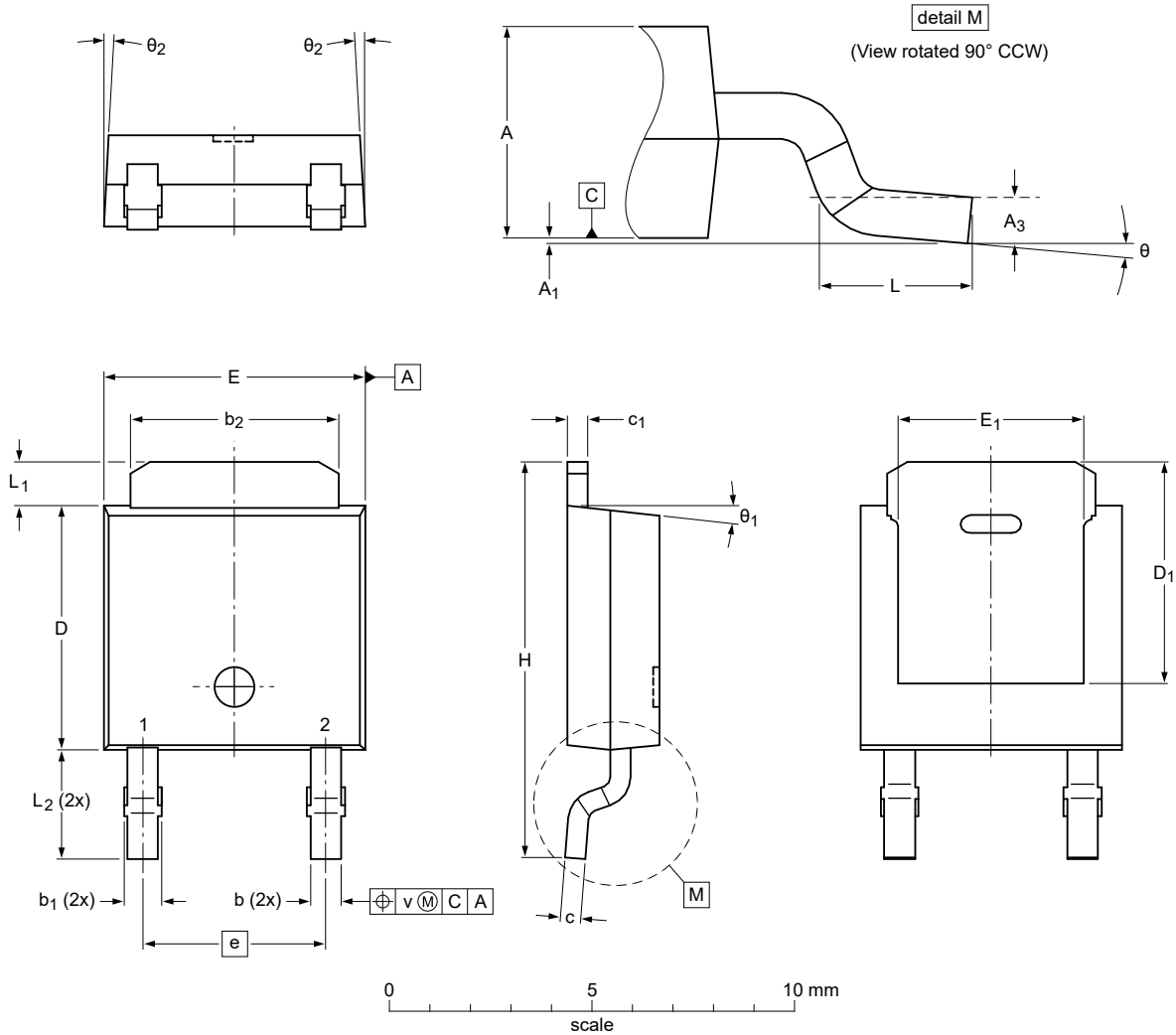

Dimensions (mm are the original dimensions)

Unit	A	A ₁	A ₃	b	b ₁	b ₂	c	c ₁	D	D ₁	E	E ₁	e	H	L	L ₁	L ₂	θ	θ ₁	θ ₂	v
max	2.39	0.13	0.51	0.89	1.13	5.46	0.61	0.60	6.22	5.70	6.73	4.80	4.58	10.34	1.78	1.27	2.74	10°	15°	3°	0.25
nom			(TYP.)														(REF.)			(REF.)	
min	2.18	0.00		0.65	0.76	4.95	0.46	0.46	5.97	5.21	6.35	4.32		9.94	1.50	0.89		0°	0°		

Note

- Dimensions "D" and "E" do not include mold flash.
- All metal surfaces are Tin plated except trimmed area.

sot8017_po

Outline version	References			European projection	Issue date
	IEC	JEDEC	JEITA		
SOT8017		TO-252 Compatible			21-11-03 24-01-17

Fig. 11. Package outline DPAK R2P (SOT8017)

13. Soldering

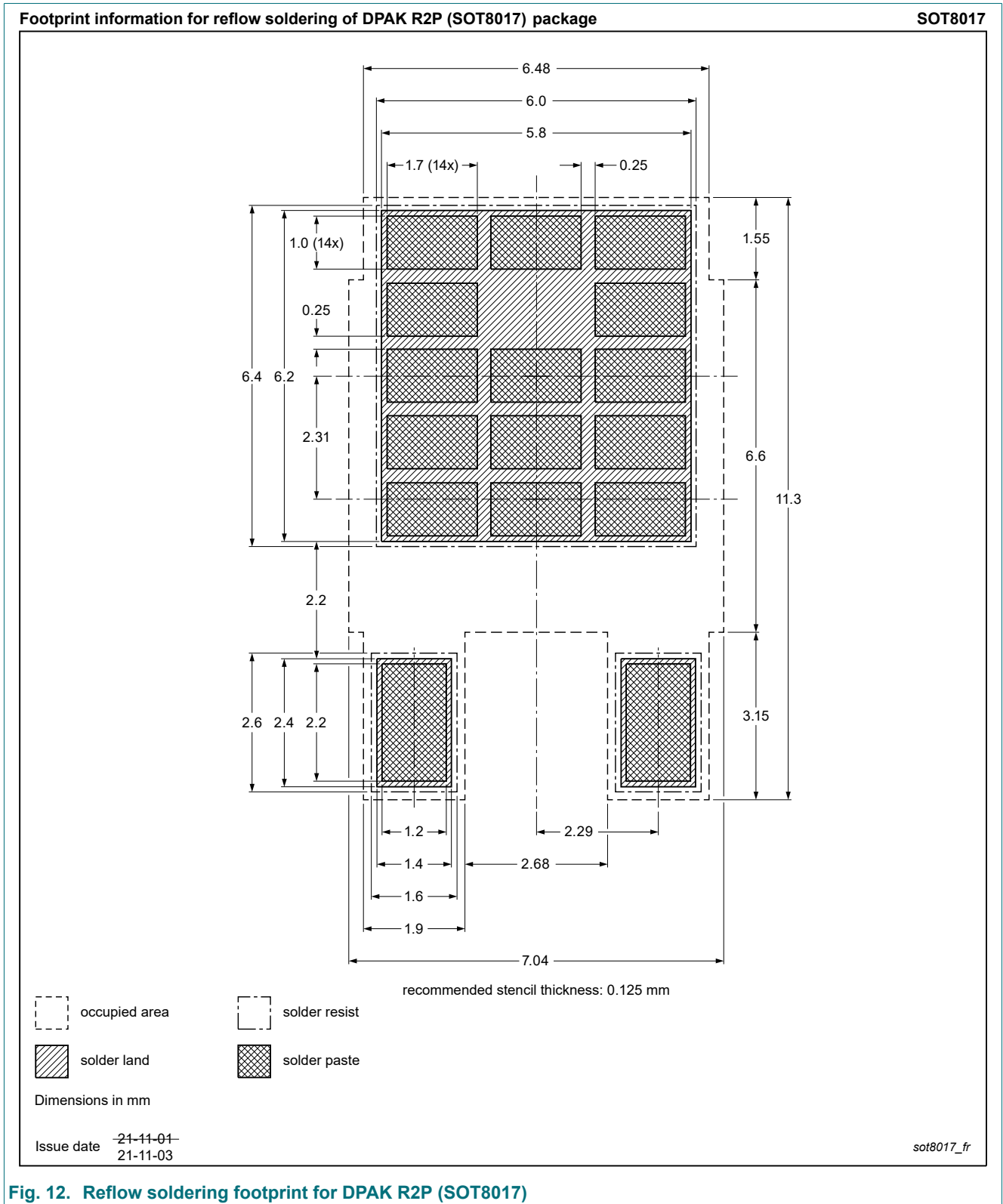

Fig. 12. Reflow soldering footprint for DPAK R2P (SOT8017)

14. Revision history

Table 8. Revision history

Data sheet ID	Release date	Data sheet status	Change notice	Supersedes
PSC1065H v.2	20240208	Product data sheet	-	PSC1065H v.1
Modifications:	• Product status changed			
PSC1065H v.1	20231211	Preliminary data sheet	-	-

15. Legal information

Data sheet status

Document status [1][2]	Product status [3]	Definition
Objective [short] data sheet	Development	This document contains data from the objective specification for product development.
Preliminary [short] data sheet	Qualification	This document contains data from the preliminary specification.
Product [short] data sheet	Production	This document contains the product specification.

- [1] Please consult the most recently issued document before initiating or completing a design.
- [2] The term 'short data sheet' is explained in section "Definitions".
- [3] The product status of device(s) described in this document may have changed since this document was published and may differ in case of multiple devices. The latest product status information is available on the internet at <https://www.nexperia.com>.

Definitions

Draft — The document is a draft version only. The content is still under internal review and subject to formal approval, which may result in modifications or additions. Nexperia does not give any representations or warranties as to the accuracy or completeness of information included herein and shall have no liability for the consequences of use of such information.

Short data sheet — A short data sheet is an extract from a full data sheet with the same product type number(s) and title. A short data sheet is intended for quick reference only and should not be relied upon to contain detailed and full information. For detailed and full information see the relevant full data sheet, which is available on request via the local Nexperia sales office. In case of any inconsistency or conflict with the short data sheet, the full data sheet shall prevail.

Product specification — The information and data provided in a Product data sheet shall define the specification of the product as agreed between Nexperia and its customer, unless Nexperia and customer have explicitly agreed otherwise in writing. In no event however, shall an agreement be valid in which the Nexperia product is deemed to offer functions and qualities beyond those described in the Product data sheet.

Disclaimers

Limited warranty and liability — Information in this document is believed to be accurate and reliable. However, Nexperia does not give any representations or warranties, expressed or implied, as to the accuracy or completeness of such information and shall have no liability for the consequences of use of such information. Nexperia takes no responsibility for the content in this document if provided by an information source outside of Nexperia.

In no event shall Nexperia be liable for any indirect, incidental, punitive, special or consequential damages (including - without limitation - lost profits, lost savings, business interruption, costs related to the removal or replacement of any products or rework charges) whether or not such damages are based on tort (including negligence), warranty, breach of contract or any other legal theory.

Notwithstanding any damages that customer might incur for any reason whatsoever, Nexperia's aggregate and cumulative liability towards customer for the products described herein shall be limited in accordance with the Terms and conditions of commercial sale of Nexperia.

Right to make changes — Nexperia reserves the right to make changes to information published in this document, including without limitation specifications and product descriptions, at any time and without notice. This document supersedes and replaces all information supplied prior to the publication hereof.

Suitability for use — Nexperia products are not designed, authorized or warranted to be suitable for use in life support, life-critical or safety-critical systems or equipment, nor in applications where failure or malfunction of an Nexperia product can reasonably be expected to result in personal

injury, death or severe property or environmental damage. Nexperia and its suppliers accept no liability for inclusion and/or use of Nexperia products in such equipment or applications and therefore such inclusion and/or use is at the customer's own risk.

Quick reference data — The Quick reference data is an extract of the product data given in the Limiting values and Characteristics sections of this document, and as such is not complete, exhaustive or legally binding.

Applications — Applications that are described herein for any of these products are for illustrative purposes only. Nexperia makes no representation or warranty that such applications will be suitable for the specified use without further testing or modification.

Customers are responsible for the design and operation of their applications and products using Nexperia products, and Nexperia accepts no liability for any assistance with applications or customer product design. It is customer's sole responsibility to determine whether the Nexperia product is suitable and fit for the customer's applications and products planned, as well as for the planned application and use of customer's third party customer(s). Customers should provide appropriate design and operating safeguards to minimize the risks associated with their applications and products.

Nexperia does not accept any liability related to any default, damage, costs or problem which is based on any weakness or default in the customer's applications or products, or the application or use by customer's third party customer(s). Customer is responsible for doing all necessary testing for the customer's applications and products using Nexperia products in order to avoid a default of the applications and the products or of the application or use by customer's third party customer(s). Nexperia does not accept any liability in this respect.

Limiting values — Stress above one or more limiting values (as defined in the Absolute Maximum Ratings System of IEC 60134) will cause permanent damage to the device. Limiting values are stress ratings only and (proper) operation of the device at these or any other conditions above those given in the Recommended operating conditions section (if present) or the Characteristics sections of this document is not warranted. Constant or repeated exposure to limiting values will permanently and irreversibly affect the quality and reliability of the device.

Terms and conditions of commercial sale — Nexperia products are sold subject to the general terms and conditions of commercial sale, as published at <http://www.nexperia.com/profile/terms>, unless otherwise agreed in a valid written individual agreement. In case an individual agreement is concluded only the terms and conditions of the respective agreement shall apply. Nexperia hereby expressly objects to applying the customer's general terms and conditions with regard to the purchase of Nexperia products by customer.

No offer to sell or license — Nothing in this document may be interpreted or construed as an offer to sell products that is open for acceptance or the grant, conveyance or implication of any license under any copyrights, patents or other industrial or intellectual property rights.

Export control — This document as well as the item(s) described herein may be subject to export control regulations. Export might require a prior authorization from competent authorities.

Non-automotive qualified products — Unless this data sheet expressly states that this specific Nexperia product is automotive qualified, the product is not suitable for automotive use. It is neither qualified nor tested in accordance with automotive testing or application requirements. Nexperia accepts no liability for inclusion and/or use of non-automotive qualified products in automotive equipment or applications.

In the event that customer uses the product for design-in and use in automotive applications to automotive specifications and standards, customer (a) shall use the product without Nexperia's warranty of the product for such automotive applications, use and specifications, and (b) whenever customer uses the product for automotive applications beyond Nexperia's specifications such use shall be solely at customer's own risk, and (c) customer fully indemnifies Nexperia for any liability, damages or failed product claims resulting from customer design and use of the product for automotive applications beyond Nexperia's standard warranty and Nexperia's product specifications.

Translations — A non-English (translated) version of a document is for reference only. The English version shall prevail in case of any discrepancy between the translated and English versions.

Trademarks

Notice: All referenced brands, product names, service names and trademarks are the property of their respective owners.

Contents

1. General description.....	1
2. Features and benefits.....	1
3. Applications.....	1
4. Quick reference data.....	1
5. Pinning information.....	2
6. Ordering information.....	2
7. Marking.....	2
8. Limiting values.....	2
9. Thermal characteristics.....	3
10. Characteristics.....	4
11. Test information.....	6
12. Package outline.....	7
13. Soldering.....	8
14. Revision history.....	9
15. Legal information.....	10

© Nexperia B.V. 2024. All rights reserved

For more information, please visit: <http://www.nexperia.com>
For sales office addresses, please send an email to: salesaddresses@nexperia.com
Date of release: 8 February 2024
