

# PBSS9110D

100 V, 1 A PNP low  $V_{CEsat}$  (BISS) transistor

Rev. 03 — 22 November 2009

Product data sheet

## 1. Product profile

### 1.1 General description

PNP low  $V_{CEsat}$  Breakthrough In Small Signal (BISS) transistor in a SOT457 (SC-74) small Surface-Mounted Device (SMD) plastic package.

NPN complement: PBSS8110D.

### 1.2 Features

- Low collector-emitter saturation voltage  $V_{CEsat}$
- High collector current capability  $I_C$  and  $I_{CM}$
- High collector current gain ( $h_{FE}$ ) at high  $I_C$
- High efficiency due to less heat generation
- Smaller required Printed-Circuit Board (PCB) area than for conventional transistors

### 1.3 Applications

- High-voltage DC-to-DC conversion
- High-voltage MOSFET gate driving
- High-voltage motor control
- High-voltage power switches (e.g. motors, fans)
- Automotive applications

### 1.4 Quick reference data

Table 1. Quick reference data

Symbol	Parameter	Conditions	Min	Typ	Max	Unit
$V_{CEO}$	collector-emitter voltage	open base	-	-	-100	V
$I_C$	collector current		-	-	-1	A
$I_{CM}$	peak collector current	single pulse; $t_p \leq 1$ ms	-	-	-3	A
$R_{CEsat}$	collector-emitter saturation resistance	$I_C = -1$ A; $I_B = -100$ mA	[1] -	170	320	m $\Omega$

[1] Pulse test:  $t_p \leq 300$   $\mu$ s;  $\delta \leq 0.02$ .

## 2. Pinning information

**Table 2. Pinning**

Pin	Description	Simplified outline	Symbol
1, 2, 5, 6	collector		 sym030
3	base		
4	emitter		

## 3. Ordering information

**Table 3. Ordering information**

Type number	Package		
	Name	Description	Version
PBSS9110D	SC-74	plastic surface-mounted package (TSOP6); 6 leads	SOT457

## 4. Marking

**Table 4. Marking codes**

Type number	Marking code
PBSS9110D	A7

## 5. Limiting values

**Table 5. Limiting values**

*In accordance with the Absolute Maximum Rating System (IEC 60134).*

Symbol	Parameter	Conditions	Min	Max	Unit	
$V_{CBO}$	collector-base voltage	open emitter	-	-120	V	
$V_{CEO}$	collector-emitter voltage	open base	-	-100	V	
$V_{EBO}$	emitter-base voltage	open collector	-	-5	V	
$I_C$	collector current		-	-1	A	
$I_{CM}$	peak collector current	single pulse; $t_p \leq 1$ ms	-	-3	A	
$I_B$	base current		-	-0.3	A	
$P_{tot}$	total power dissipation	$T_{amb} \leq 25$ °C	[1]	-	300	mW
			[2]	-	550	mW
			[3]	-	700	mW

**Table 5. Limiting values ...continued**

In accordance with the Absolute Maximum Rating System (IEC 60134).

Symbol	Parameter	Conditions	Min	Max	Unit
$T_j$	junction temperature		-	150	°C
$T_{amb}$	ambient temperature		-65	+150	°C
$T_{stg}$	storage temperature		-65	+150	°C

[1] Device mounted on an FR4 PCB, single-sided copper, tin-plated and standard footprint.

[2] Device mounted on an FR4 PCB, single-sided copper, tin-plated, mounting pad for collector 1cm<sup>2</sup>.

[3] Device mounted on an FR4 PCB, single-sided copper, tin-plated, mounting pad for collector 6cm<sup>2</sup>.

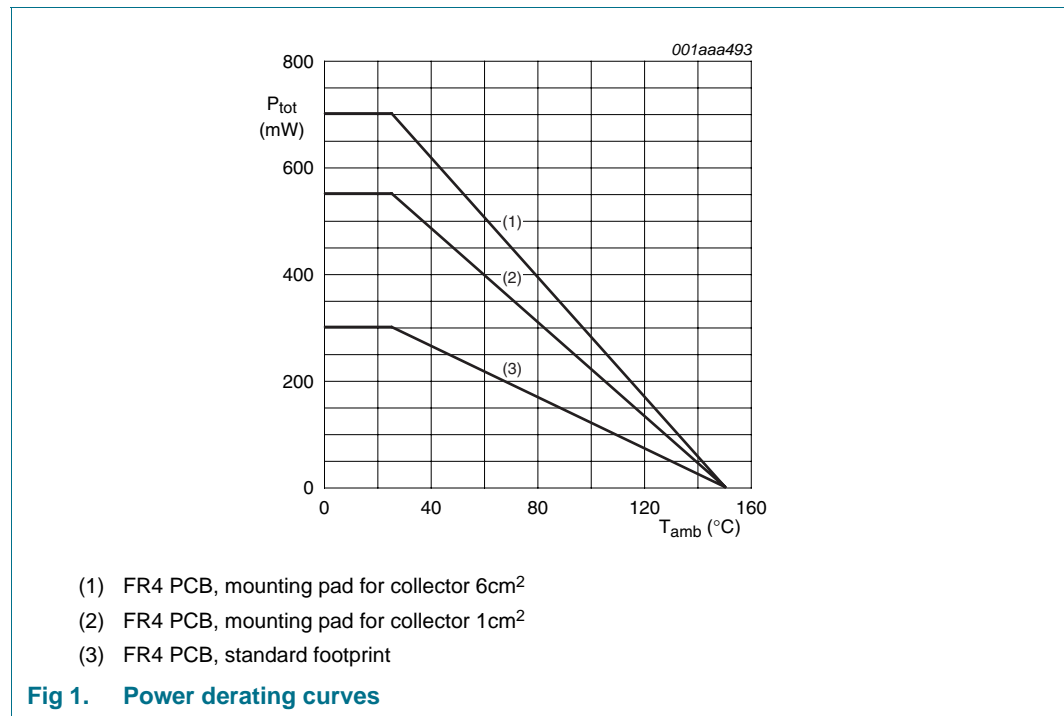

## 6. Thermal characteristics

**Table 6. Thermal characteristics**

Symbol	Parameter	Conditions	Min	Typ	Max	Unit	
$R_{th(j-a)}$	thermal resistance from junction to ambient	in free air	[1]	-	-	416	K/W
			[2]	-	-	227	K/W
			[3]	-	-	178	K/W
$R_{th(j-sp)}$	thermal resistance from junction to solder point		-	-	83	K/W	

[1] Device mounted on an FR4 PCB, single-sided copper, tin-plated and standard footprint.

[2] Device mounted on an FR4 PCB, single-sided copper, tin-plated, mounting pad for collector 1cm<sup>2</sup>.

[3] Device mounted on an FR4 PCB, single-sided copper, tin-plated, mounting pad for collector 6cm<sup>2</sup>.

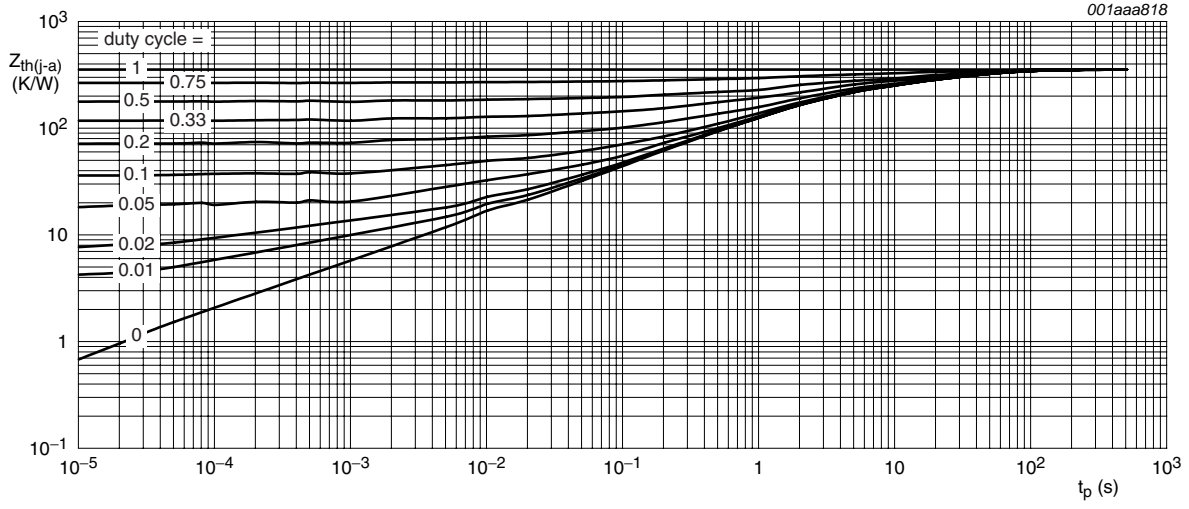

FR4 PCB, standard footprint

Fig 2. Transient thermal impedance from junction to ambient as a function of pulse duration; typical values

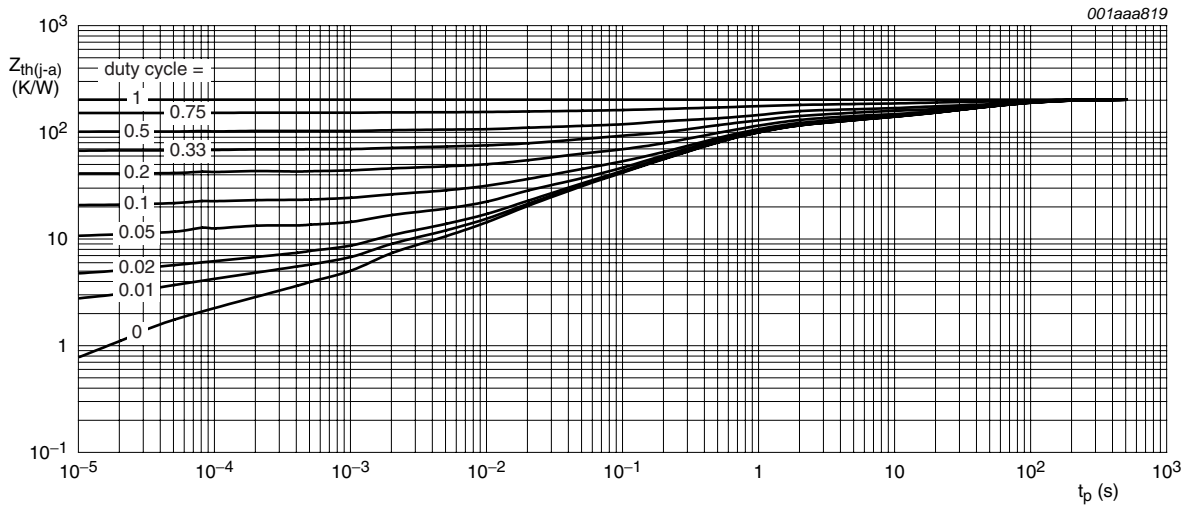

FR4 PCB, mounting pad for collector 1cm<sup>2</sup>

Fig 3. Transient thermal impedance from junction to ambient as a function of pulse duration; typical values

## 7. Characteristics

**Table 7. Characteristics**
 $T_{amb} = 25\text{ }^{\circ}\text{C}$  unless otherwise specified.

Symbol	Parameter	Conditions	Min	Typ	Max	Unit
$I_{CBO}$	collector-base cut-off current	$V_{CB} = -80\text{ V}; I_E = 0\text{ A}$	-	-	-100	nA
		$V_{CB} = -80\text{ V}; I_E = 0\text{ A}; T_j = 150\text{ }^{\circ}\text{C}$	-	-	-50	$\mu\text{A}$
$I_{CES}$	collector-emitter cut-off current	$V_{CE} = -80\text{ V}; V_{BE} = 0\text{ V}$	-	-	-100	nA
$I_{EBO}$	emitter-base cut-off current	$V_{EB} = -4\text{ V}; I_C = 0\text{ A}$	-	-	-100	nA
$h_{FE}$	DC current gain	$V_{CE} = -5\text{ V}; I_C = -1\text{ mA}$	150	-	-	
		$V_{CE} = -5\text{ V}; I_C = -250\text{ mA}$	150	-	-	
		$V_{CE} = -5\text{ V}; I_C = -0.5\text{ A}$	[1] 150	-	450	
		$V_{CE} = -5\text{ V}; I_C = -1\text{ A}$	[1] 125	-	-	
$V_{CEsat}$	collector-emitter saturation voltage	$I_C = -250\text{ mA}; I_B = -25\text{ mA}$	-	-	-120	mV
		$I_C = -0.5\text{ A}; I_B = -50\text{ mA}$	[1] -	-	-180	mV
		$I_C = -1\text{ A}; I_B = -100\text{ mA}$	[1] -	-	-320	mV
$R_{CEsat}$	collector-emitter saturation resistance	$I_C = -1\text{ A}; I_B = -100\text{ mA}$	[1] -	170	320	$\text{m}\Omega$
$V_{BEsat}$	base-emitter saturation voltage	$I_C = -1\text{ A}; I_B = -100\text{ mA}$	[1] -	-	-1.1	V
$V_{BEon}$	base-emitter turn-on voltage	$V_{CE} = -5\text{ V}; I_C = -1\text{ A}$	-	-	-1.0	V
$t_d$	delay time	$V_{CC} = -10\text{ V}; I_C = -0.5\text{ A}; I_{Bon} = -0.025\text{ A}; I_{Boff} = 0.025\text{ A}$	-	20	-	ns
$t_r$	rise time		-	60	-	ns
$t_{on}$	turn-on time		-	80	-	ns
$t_s$	storage time		-	290	-	ns
$t_f$	fall time		-	120	-	ns
$t_{off}$	turn-off time		-	410	-	ns
$f_T$	transition frequency	$V_{CE} = -10\text{ V}; I_C = -50\text{ mA}; f = 100\text{ MHz}$	100	-	-	MHz
$C_C$	collector capacitance	$V_{CB} = -10\text{ V}; I_E = I_e = 0\text{ A}; f = 1\text{ MHz}$	-	-	17	pF

[1] Pulse test:  $t_p \leq 300\text{ }\mu\text{s}; \delta \leq 0.02$ .

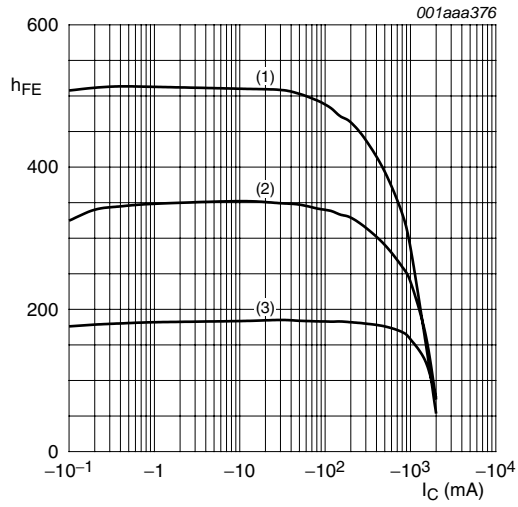

$V_{CE} = -10$  V  
 (1)  $T_{amb} = 100$  °C  
 (2)  $T_{amb} = 25$  °C  
 (3)  $T_{amb} = -55$  °C

**Fig 4. DC current gain as a function of collector current; typical values**

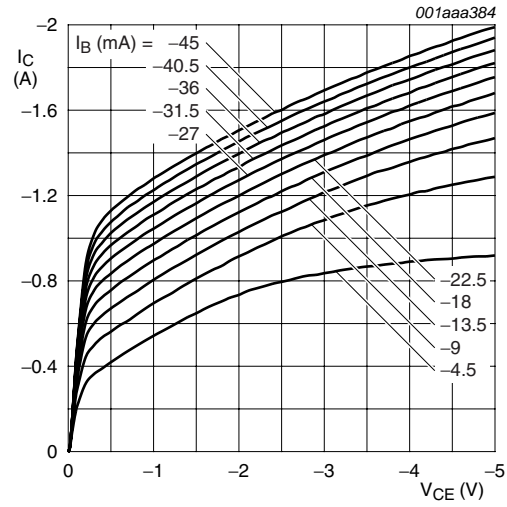

$T_{amb} = 25$  °C

**Fig 5. Collector current as a function of collector-emitter voltage; typical values**

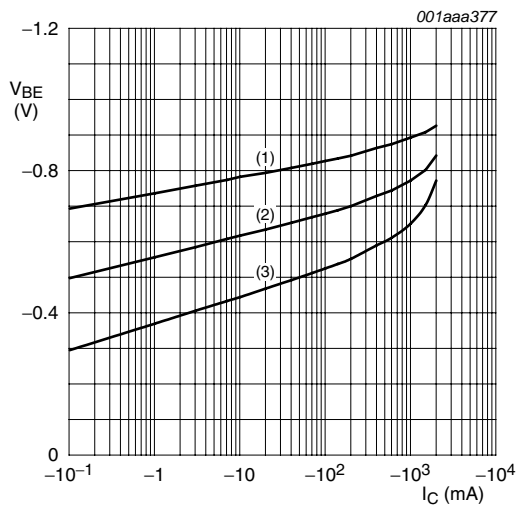

$V_{CE} = -10$  V  
 (1)  $T_{amb} = -55$  °C  
 (2)  $T_{amb} = 25$  °C  
 (3)  $T_{amb} = 100$  °C

**Fig 6. Base-emitter voltage as a function of collector current; typical values**

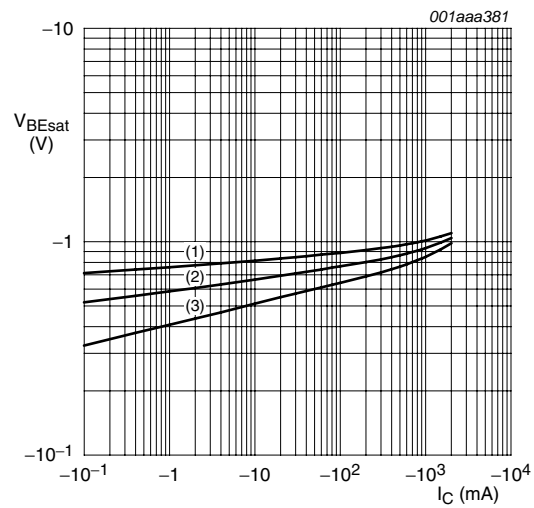

$I_C/I_B = 10$   
 (1)  $T_{amb} = -55$  °C  
 (2)  $T_{amb} = 25$  °C  
 (3)  $T_{amb} = 100$  °C

**Fig 7. Base-emitter saturation voltage as a function of collector current; typical values**

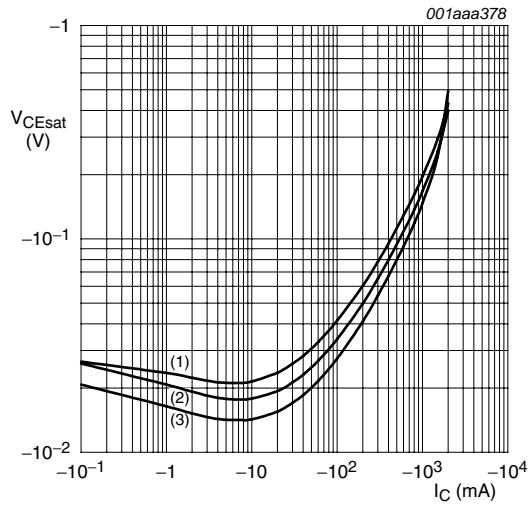

$I_C/I_B = 10$   
 (1)  $T_{amb} = 100\text{ °C}$   
 (2)  $T_{amb} = 25\text{ °C}$   
 (3)  $T_{amb} = -55\text{ °C}$

**Fig 8. Collector-emitter saturation voltage as a function of collector current; typical values**

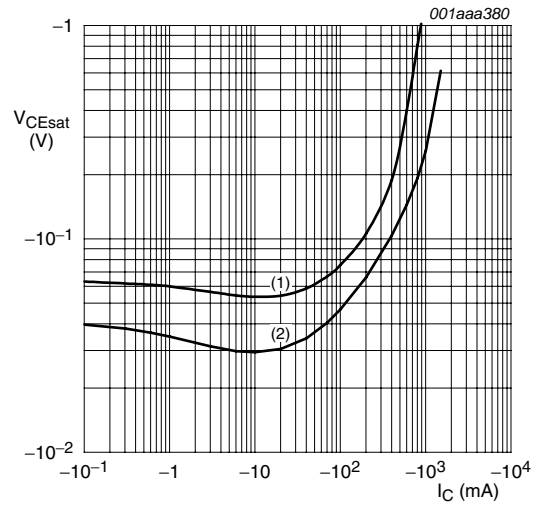

$T_{amb} = 25\text{ °C}$   
 (1)  $I_C/I_B = 50$   
 (2)  $I_C/I_B = 20$

**Fig 9. Collector-emitter saturation voltage as a function of collector current; typical values**

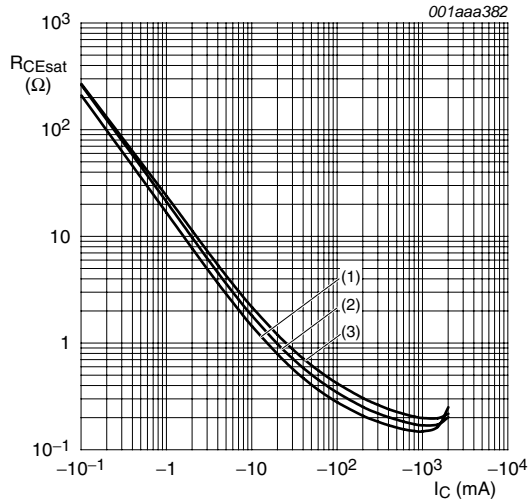

$I_C/I_B = 10$   
 (1)  $T_{amb} = -55\text{ °C}$   
 (2)  $T_{amb} = 25\text{ °C}$   
 (3)  $T_{amb} = 100\text{ °C}$

**Fig 10. Collector-emitter saturation resistance as a function of collector current; typical values**

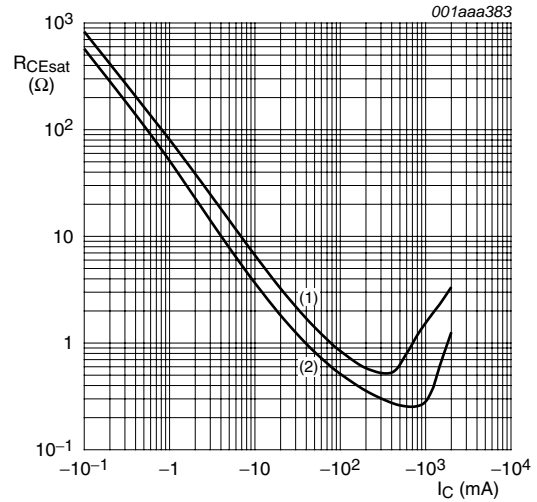

$T_{amb} = 25\text{ °C}$   
 (1)  $I_C/I_B = 50$   
 (2)  $I_C/I_B = 20$

**Fig 11. Collector-emitter saturation resistance as a function of collector current; typical values**

8. Test information

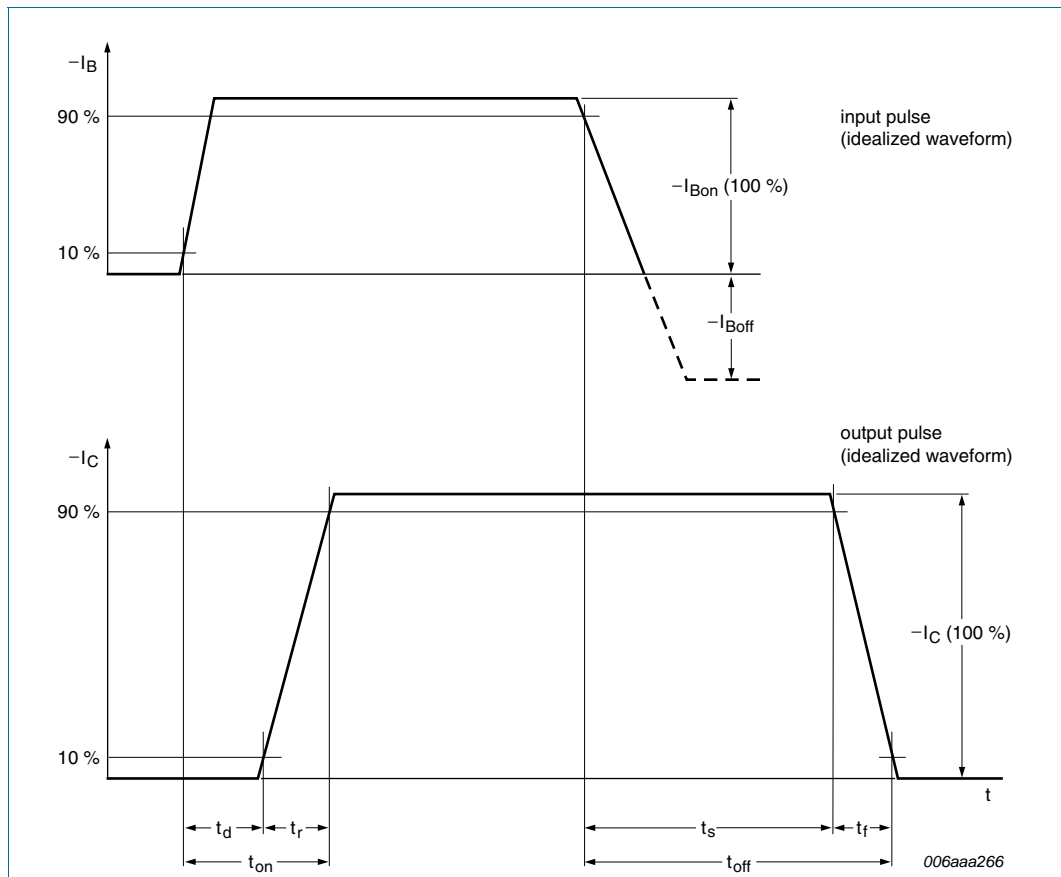
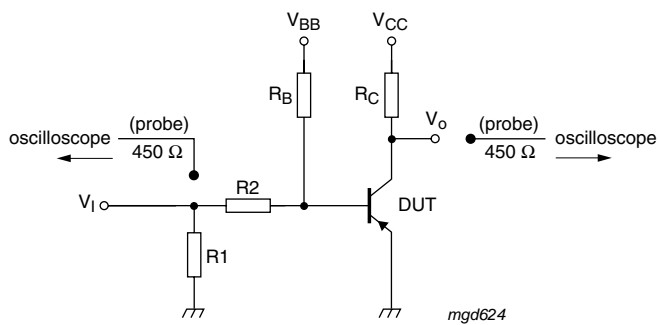

Fig 12. BISS transistor switching time definition



$V_{CC} = -10\text{ V}$ ;  $I_C = -0.5\text{ A}$ ;  $I_{Bon} = -0.025\text{ A}$ ;  $I_{Boff} = 0.025\text{ A}$

Fig 13. Test circuit for switching times



## 9. Package outline

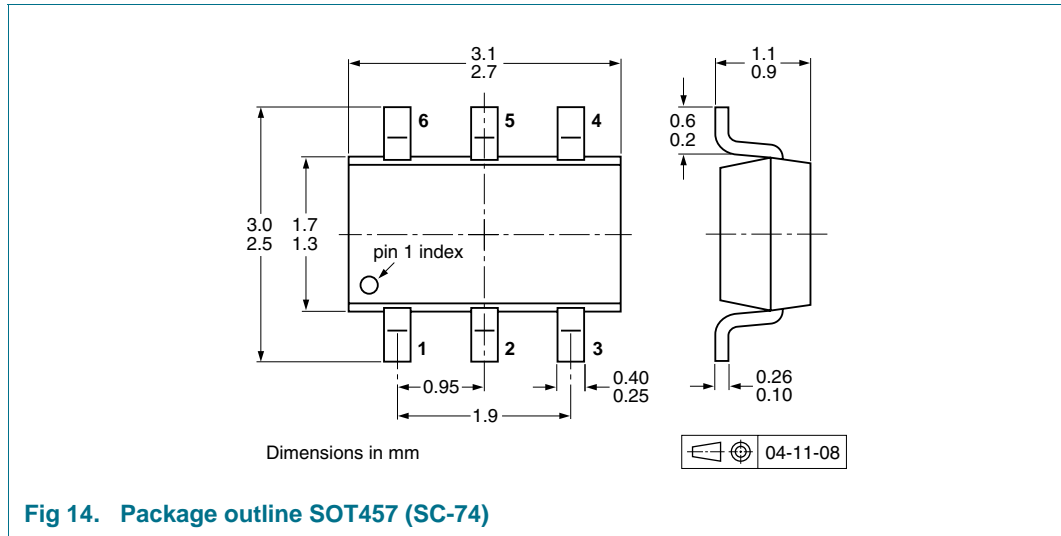

Fig 14. Package outline SOT457 (SC-74)

## 10. Packing information

**Table 8. Packing methods**

The indicated -xxx are the last three digits of the 12NC ordering code.<sup>[1]</sup>

Type number	Package	Description	Packing quantity	
			3000	10000
PBSS9110D	SOT457	4 mm pitch, 8 mm tape and reel; T1	<sup>[2]</sup> -115	-135
		4 mm pitch, 8 mm tape and reel; T2	<sup>[3]</sup> -125	-165

[1] For further information and the availability of packing methods, see [Section 14](#).

[2] T1: normal taping

[3] T2: reverse taping

11. Soldering

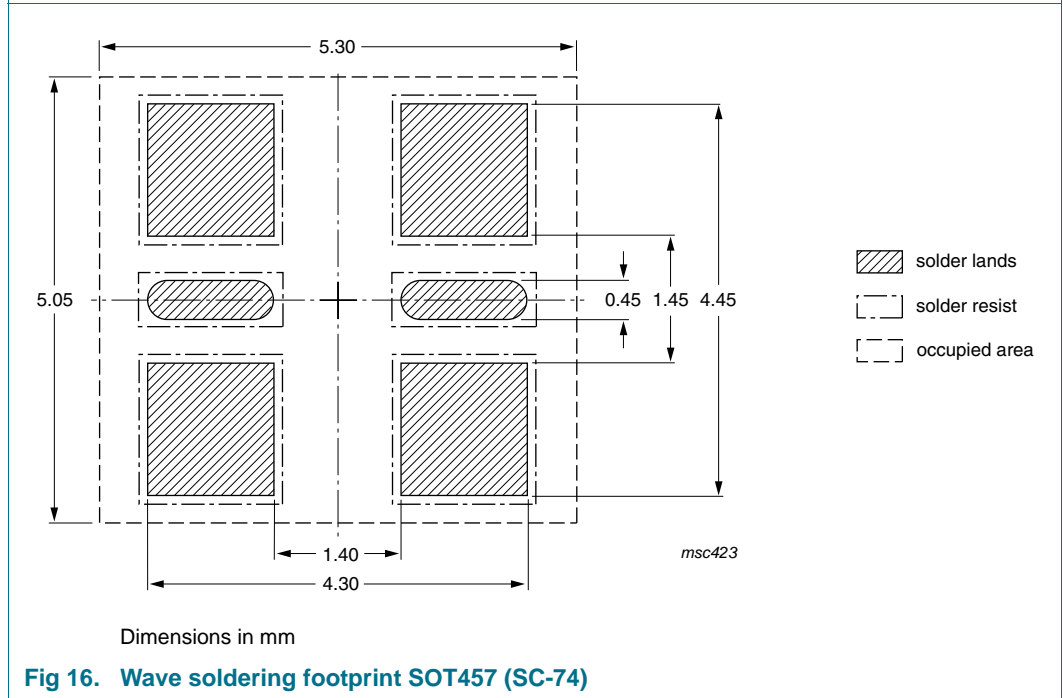
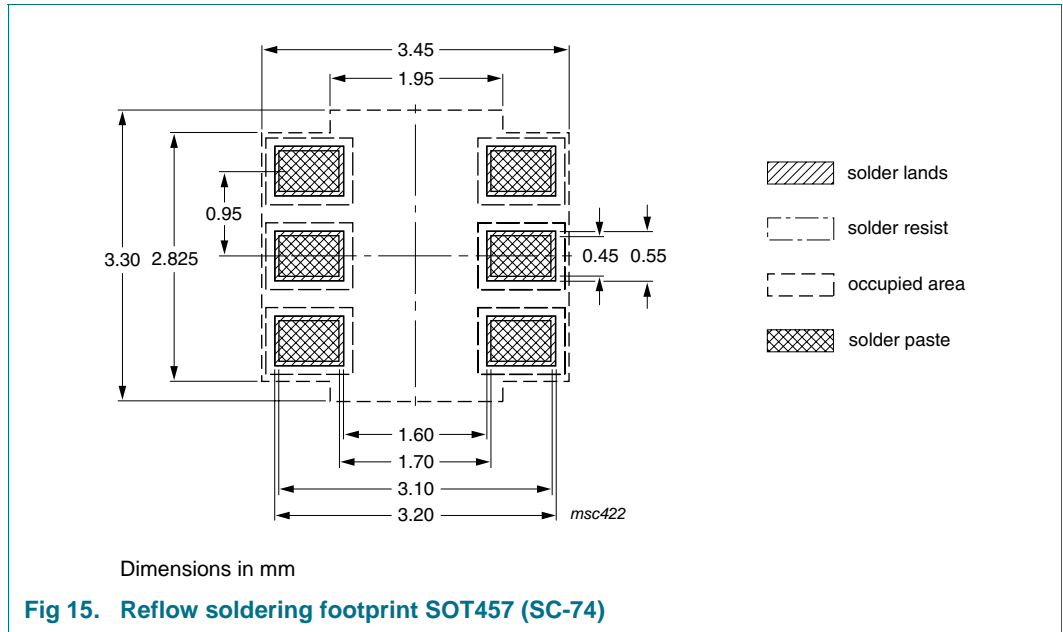

## 12. Revision history

Table 9. Revision history

Document ID	Release date	Data sheet status	Change notice	Supersedes
PBSS9110D_3	20091122	Product data sheet	-	PBSS9110D_2
Modifications:		<ul style="list-style-type: none"><li>This data sheet was changed to reflect the new company name NXP Semiconductors, including new legal definitions and disclaimers. No changes were made to the technical content.</li><li><a href="#">Figure 16 "Wave soldering footprint SOT457 (SC-74)": updated</a></li></ul>		
PBSS9110D_2	20060713	Product data sheet	-	PBSS9110D_1
PBSS9110D_1	20040611	Objective data sheet	-	-

## 13. Legal information

### 13.1 Data sheet status

Document status <sup>[1][2]</sup>	Product status <sup>[3]</sup>	Definition
Objective [short] data sheet	Development	This document contains data from the objective specification for product development.
Preliminary [short] data sheet	Qualification	This document contains data from the preliminary specification.
Product [short] data sheet	Production	This document contains the product specification.

[1] Please consult the most recently issued document before initiating or completing a design.

[2] The term 'short data sheet' is explained in section "Definitions".

[3] The product status of device(s) described in this document may have changed since this document was published and may differ in case of multiple devices. The latest product status information is available on the Internet at URL <http://www.nxp.com>.

### 13.2 Definitions

**Draft** — The document is a draft version only. The content is still under internal review and subject to formal approval, which may result in modifications or additions. NXP Semiconductors does not give any representations or warranties as to the accuracy or completeness of information included herein and shall have no liability for the consequences of use of such information.

**Short data sheet** — A short data sheet is an extract from a full data sheet with the same product type number(s) and title. A short data sheet is intended for quick reference only and should not be relied upon to contain detailed and full information. For detailed and full information see the relevant full data sheet, which is available on request via the local NXP Semiconductors sales office. In case of any inconsistency or conflict with the short data sheet, the full data sheet shall prevail.

### 13.3 Disclaimers

**General** — Information in this document is believed to be accurate and reliable. However, NXP Semiconductors does not give any representations or warranties, expressed or implied, as to the accuracy or completeness of such information and shall have no liability for the consequences of use of such information.

**Right to make changes** — NXP Semiconductors reserves the right to make changes to information published in this document, including without limitation specifications and product descriptions, at any time and without notice. This document supersedes and replaces all information supplied prior to the publication hereof.

**Suitability for use** — NXP Semiconductors products are not designed, authorized or warranted to be suitable for use in medical, military, aircraft, space or life support equipment, nor in applications where failure or malfunction of an NXP Semiconductors product can reasonably be expected to result in personal injury, death or severe property or environmental

damage. NXP Semiconductors accepts no liability for inclusion and/or use of NXP Semiconductors products in such equipment or applications and therefore such inclusion and/or use is at the customer's own risk.

**Applications** — Applications that are described herein for any of these products are for illustrative purposes only. NXP Semiconductors makes no representation or warranty that such applications will be suitable for the specified use without further testing or modification.

**Limiting values** — Stress above one or more limiting values (as defined in the Absolute Maximum Ratings System of IEC 60134) may cause permanent damage to the device. Limiting values are stress ratings only and operation of the device at these or any other conditions above those given in the Characteristics sections of this document is not implied. Exposure to limiting values for extended periods may affect device reliability.

**Terms and conditions of sale** — NXP Semiconductors products are sold subject to the general terms and conditions of commercial sale, as published at <http://www.nxp.com/profile/terms>, including those pertaining to warranty, intellectual property rights infringement and limitation of liability, unless explicitly otherwise agreed to in writing by NXP Semiconductors. In case of any inconsistency or conflict between information in this document and such terms and conditions, the latter will prevail.

**No offer to sell or license** — Nothing in this document may be interpreted or construed as an offer to sell products that is open for acceptance or the grant, conveyance or implication of any license under any copyrights, patents or other industrial or intellectual property rights.

**Export control** — This document as well as the item(s) described herein may be subject to export control regulations. Export might require a prior authorization from national authorities.

**Quick reference data** — The Quick reference data is an extract of the product data given in the Limiting values and Characteristics sections of this document, and as such is not complete, exhaustive or legally binding.

### 13.4 Trademarks

Notice: All referenced brands, product names, service names and trademarks are the property of their respective owners.

## 14. Contact information

For more information, please visit: <http://www.nxp.com>

For sales office addresses, please send an email to: [salesaddresses@nxp.com](mailto:salesaddresses@nxp.com)

## 15. Contents

<b>1</b>	<b>Product profile</b> . . . . .	<b>1</b>
1.1	General description . . . . .	1
1.2	Features . . . . .	1
1.3	Applications . . . . .	1
1.4	Quick reference data . . . . .	1
<b>2</b>	<b>Pinning information</b> . . . . .	<b>2</b>
<b>3</b>	<b>Ordering information</b> . . . . .	<b>2</b>
<b>4</b>	<b>Marking</b> . . . . .	<b>2</b>
<b>5</b>	<b>Limiting values</b> . . . . .	<b>2</b>
<b>6</b>	<b>Thermal characteristics</b> . . . . .	<b>3</b>
<b>7</b>	<b>Characteristics</b> . . . . .	<b>5</b>
<b>8</b>	<b>Test information</b> . . . . .	<b>8</b>
<b>9</b>	<b>Package outline</b> . . . . .	<b>9</b>
<b>10</b>	<b>Packing information</b> . . . . .	<b>9</b>
<b>11</b>	<b>Soldering</b> . . . . .	<b>10</b>
<b>12</b>	<b>Revision history</b> . . . . .	<b>11</b>
<b>13</b>	<b>Legal information</b> . . . . .	<b>12</b>
13.1	Data sheet status . . . . .	12
13.2	Definitions . . . . .	12
13.3	Disclaimers . . . . .	12
13.4	Trademarks . . . . .	12
<b>14</b>	<b>Contact information</b> . . . . .	<b>12</b>
<b>15</b>	<b>Contents</b> . . . . .	<b>13</b>

Please be aware that important notices concerning this document and the product(s) described herein, have been included in section 'Legal information'.



© NXP B.V. 2009.

All rights reserved.

For more information, please visit: <http://www.nxp.com>

For sales office addresses, please send an email to: [salesaddresses@nxp.com](mailto:salesaddresses@nxp.com)

Date of release: 22 November 2009

Document identifier: PBSS9110D\_3