

Important notice

Dear Customer,

On 7 February 2017 the former NXP Standard Product business became a new company with the tradename **Nexperia**. Nexperia is an industry leading supplier of Discrete, Logic and PowerMOS semiconductors with its focus on the automotive, industrial, computing, consumer and wearable application markets

In data sheets and application notes which still contain NXP or Philips Semiconductors references, use the references to Nexperia, as shown below.

Instead of <http://www.nxp.com>, <http://www.philips.com/> or <http://www.semiconductors.philips.com/>, use <http://www.nexperia.com>

Instead of sales.addresses@www.nxp.com or sales.addresses@www.semiconductors.philips.com, use salesaddresses@nexperia.com (email)

Replace the copyright notice at the bottom of each page or elsewhere in the document, depending on the version, as shown below:

- © NXP N.V. (year). All rights reserved or © Koninklijke Philips Electronics N.V. (year). All rights reserved

Should be replaced with:

- © **Nexperia B.V. (year). All rights reserved.**

If you have any questions related to the data sheet, please contact our nearest sales office via e-mail or telephone (details via salesaddresses@nexperia.com). Thank you for your cooperation and understanding,

Kind regards,

Team Nexperia

APPLICATION NOTE

**90W Resonant SMPS
with TEA1610 SwingChip™**

AN99011

Abstract

This report describes a 90W Resonant Switched Mode Power Supply (ResSMPS) for a typical TV or monitor application based upon the TEA1610 SwingChip™ resonant SMPS controller. The power supply is based on the half bridge DC-to-DC resonant LLC converter with zero-voltage switching. The TEA1610 uses current driven frequency control.

© Philips Electronics N.V. 1999

All rights are reserved. Reproduction in whole or in part is prohibited without the prior written consent of the copyright owner.

The information presented in this document does not form part of any quotation or contract, is believed to be accurate and reliable and may be changed without notice. No liability will be accepted by the publisher for any consequence of its use. Publication thereof does not convey nor imply any license under patent- or other industrial or intellectual property rights.

APPLICATION NOTE

**90W Resonant SMPS
with TEA1610 SwingChip™**

AN99011

Author:

R.Kennis

**Philips Semiconductors Systems Laboratory Eindhoven,
The Netherlands**

Approved by:

T. Mober

E. Derckx

Keywords

SwingChip™

TEA1610

Resonant

SMPS

Zero-voltage-switching

Number of pages: 27

Date: 99-09-14

Summary

The SwingChip™ TEA1610 controller is a monolithic integrated circuit and is implemented on the 650V BCD power logic process. The IC provides the drive function for two discrete power MOSFETs in a half bridge configuration and is a high voltage controller for a zero-voltage switching resonant converter. To guarantee an accurate 50% duty cycle, the oscillator signal passes through a divider before being fed to the output drivers.

This application note briefly describes a 90W Resonant Converter for a typical TV or monitor application based upon the TEA1610 controller. The converter is composed of two bi-directional switches and a resonant LLC-circuit. To limit the costs the two inductors are integrated in one transformer: a magnetising inductance and a leakage inductance, which is cheaper than two separate coils. With a certain coupling of about 0.6 the leakage inductance is given the required value. The outputs are mains isolated and the 80V is controlled secondary. The converter has a high performance efficiency and a very good cross regulation

CONTENTS

1 INTRODUCTION 7

2 FEATURES..... 7

3 QUICK REFERENCE DATA 8

4 FUNCTIONAL BLOCK DIAGRAM..... 9

5 CIRCUIT DESCRIPTION..... 10

5.1 Mains input circuit..... 10

5.2 Half bridge switches 10

5.3 Transformer 10

5.4 Output section 10

5.5 Regulation, opto coupler and controller..... 11

5.6 Start-up..... 11

5.7 Protections..... 12

 5.7.1 Under Voltage Lock Out (UVLO) and Short Circuit Protection..... 12

 5.7.2 Over Voltage Protection (OVP) 12

 5.7.3 Over Current Protection (OCP)..... 12

6 MEASUREMENTS 13

6.1 Static performance 13

6.2 Dynamic performance 16

6.3 Bode diagrams 17

6.4 EMI results..... 18

7 CIRCUIT DIAGRAM 19

8 LAYOUT CONSIDERATIONS..... 21

9 PARTS LIST 25

10 REFERENCES 27

1 INTRODUCTION

The TV and monitor market demands more and more high-quality, reliable, small, lightweight and efficient power supplies. In principle the higher the operating frequency the smaller and lighter the transformers, filter inductors and capacitors can be. A remark on this is that the core and winding losses of the transformer will increase at higher frequencies and become dominant. This effect reduces the efficiency at a high frequency, which limits the minimum size of the transformer. The corner frequency of the output filter usually determines the band width of the control loop. A well chosen corner frequency allows high operating frequencies for achieving a fast dynamic response.

At this moment the Pulse Width Modulated power converters, such as the fly back, up and down converter, are widely used in low and medium

power applications. A disadvantage of these converters is that the PWM rectangular voltage and current waveforms cause turn-on and turn-off losses that limit the operating frequency. The rectangular waveforms generate also broad band electromagnetic energy, what can produce Electromagnetic Interference (EMI). A resonant DC-DC converter produces sinusoidal waveforms and reduces the switching losses, what gives the possibility to operate at higher frequencies

The resonant converter can be separated into three cascaded blocks: a AC-to-DC mains rectifier, a DC-to-AC inverter and an AC-to-DC output rectifier (figure 2 represents the last two blocks: the inverter and the output rectifier).

2 FEATURES

- Full mains input range 85-276V_{AC}
- Continuous Output Power 90W
- Output voltages: 190V, 80V, +13V, +5V, -6.2V and -13V
- Zero voltage switching
- (EMI friendly)
- Main output short circuit proof

3 QUICK REFERENCE DATA

SYMBOL	PARAMETER	CONDITIONS	MIN.	TYP.	MAX.	UNIT
Supply						
V_{line}	mains voltage	nominal operation	85		276	V_{AC}
f_{line}	mains frequency	nominal operation		50 / 60		Hz
Output voltages						
V_{OUT1}	main output voltage	all conditions		80.0		V_{DC}
$V_{OUT1,fl}$	100Hz ripple	$V_{line} = 230V_{AC}, I_{OUT1} = 250\text{ mA}$			75	mV_{ACpp}
$V_{OUT1,fs}$	high frequency ripple	$V_{line} = 230V_{AC}, I_{OUT1} = 250\text{ mA}$			50	mV_{ACpp}
$\Delta V_{OUT1,line}$	line regulation				100	mV_{DC}
$\Delta V_{OUT1,load}$	load regulation	10 – 100% load			10	mV_{DC}
I_{OUT1}	main output current			135	225	mA_{DC}
V_{OUT2}	output 2 voltage		192.3	193.0	193.9	V_{DC}
I_{OUT2}	output 2 current			190	243	mA_{DC}
V_{OUT3}	output 3 voltage		11.7	12.4	13.0	V_{DC}
I_{OUT3}	output 3 current			670	890	mA_{DC}
V_{OUT4}	output 4 voltage		-12.9	-12.4	-11.7	V_{DC}
I_{OUT4}	output 4 current			240	890	mA_{DC}
V_{OUT5}	output 5 voltage		-6.3	-6.3	-6.4	V_{DC}
I_{OUT5}	output 5 current				650	mA
V_{OUT6}	output 6 voltage			5.0		V_{DC}
I_{OUT6}	output 6 current			43	50	mA
Miscellaneous						
t_{START}	start-up time			600		msec
η	efficiency	measured at maximum load, spread over V_{OUT1} and V_{OUT2}	89	91	92	%
P_{MAX}	maximum output power			90		W

V_{OUT5} and V_{OUT6} are post regulated.

4 FUNCTIONAL BLOCK DIAGRAM

Figure 1 shows the functional block diagram of the application. The topology which is used is the half bridge resonant converter. A reduction of EMI and especially self-pollution is achieved by zero voltage switching (ZVS) in the MOSFETs and output diodes. Another advantage of ZVS are the lower switching losses. Figure 2 shows the basic circuit of the LLC-converter, which represents the blocks 'Half bridge switches', 'Transformer' and 'Output section'. The DC-input voltage is

converted by the switches into a block voltage with a duty cycle of 50%. The LLC circuit converts this block voltage to a sinusoidal current through its components and a sinusoidal voltage across the resonant capacitor C_r . This capacitor is acting at the same time as blocking element for DC. The transformer reflects (with winding ratio) the voltage across L_p to the secondary, where it is rectified and smoothed by the output capacitor.

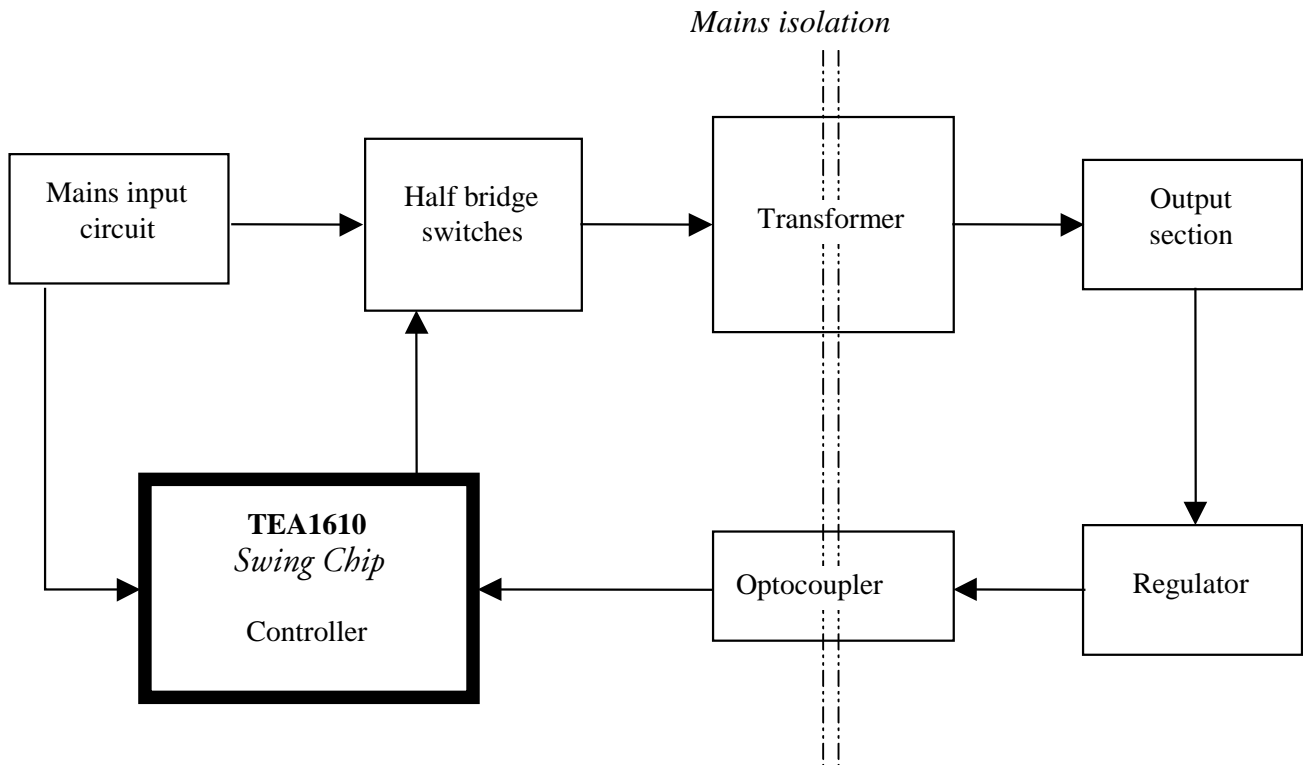

Figure 1 Functional block diagram

The auxiliary winding which supplies the controller has a good coupling with the output voltage and monitored by the controller. When this voltage becomes too high the converter will be switched off, this is called Over Voltage Protection (OVP). The primary resonant current is also guarded to protect the MOSFETs in fault conditions, when the current becomes too high, this is called Over Current Protection (OCP). One of the output voltages,

the 80V-supply, is controlled by means of a secondary regulator circuit that communicates with the TEA1610 controller section by means of an opto coupler, which is used for mains isolation.

5 CIRCUIT DESCRIPTION

5.1 Mains input circuit

The input circuit is a conventional full bridge rectifier. A common mode filter is included for mains conducted EMI suppression. A degaussing circuit is not included. A standard PTC degaussing circuit can be added. To gain full advantage in terms of power consumption in the 'OFF' mode a circuit to switch-off the degaussing PTC during these modes should be added.

5.2 Half bridge switches

The body diodes D1 and D2 of the half bridge MOSFETs are conducting during a part of the primary resonant current. The capacitors C1 and C2 (see Figure 2) are the voltage resonant capacitors which are reducing the TURN-OFF dissipation and so the EMI produced by each MOSFET by a proper dV/dt .

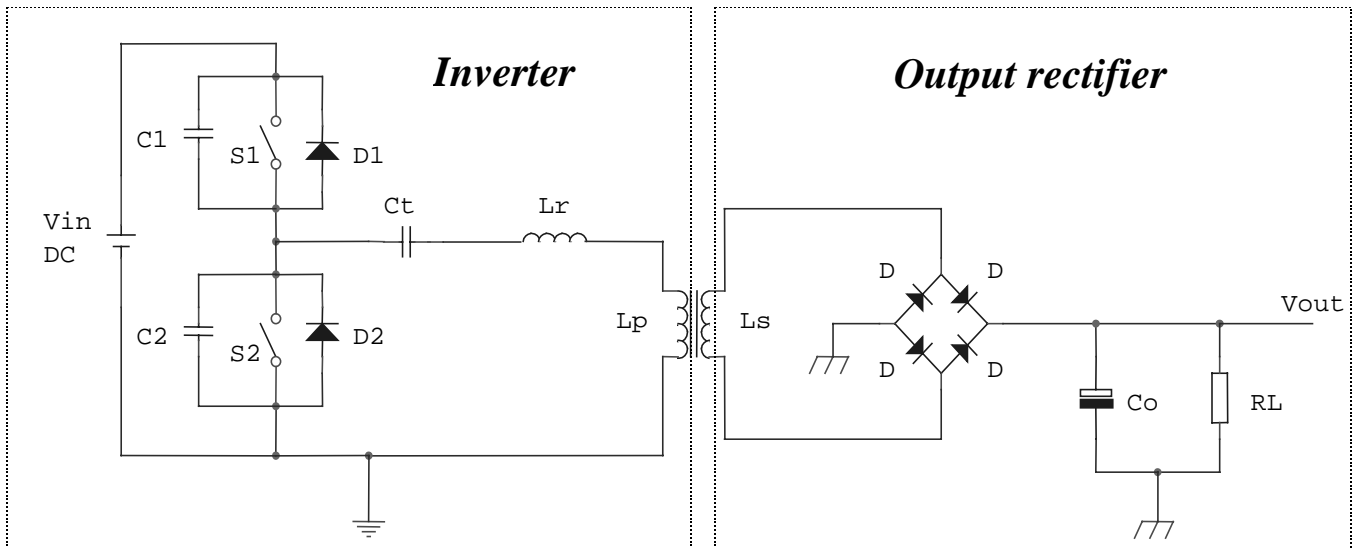

Figure 2 Basic circuit LLC-converter

5.3 Transformer

The inductors L_r and L_p are combined on a single mains-isolated transformer with a poor coupling factor between primary and secondary. In this case the transformer behaves as an ideal transformer having a magnetising inductance L_p with a primary (L_{r_p}) and a secondary leakage inductance (L_{r_s}) transferred to the primary ($L_r = L_{r_p} + L_{r_s}$). The transformer is designed to have an output voltage of 6.67V per turn. The output voltage can be chosen in 6.67V steps minus one diode forward drop.

5.4 Output section

Three types of rectifiers are used. A bridge rectifier for the 190V, a centre-tapped double side rectifier for the 80V and single side rectifiers for the +13 and -13V supplies. All these voltage contains a π -output filter (C-L-C). The 5V and -6.2V supply are derived out of the +13V and -13V respectively.

5.5 Regulation, opto coupler and controller

The TEA1610 can be used either with primary sensing as well as secondary sensing. Primary sensing is cheaper but output regulation is less accurate, especially in this application where the coupling of the primary and secondary is made purposely poor. Secondary sensing is more expensive but has a higher performance. For that reason this 90W application uses secondary sensing. Component Z1 (see chapter 7, page 19) is a TL431 voltage regulator that feeds an error signal through OC1 (CNX82A opto coupler) back to the control input IRS of the TEA1610. The TEA1610 uses this information to control an internal frequency modulator (FM). The FM is connected to the (high and low) output gate drivers to control the MOSFETs. The supply is designed to operate at a 50% duty cycle per MOSFET. When less output power is required or the input voltage is increased the frequency will be made higher by the control loop to maintain a constant output voltage. To guarantee an accurate 50% duty cycle, the oscillator signal inside the TEA1610 passes through a divider before it is fed to the output gate drivers.

Figure 6 shows the load step response (-49dB) of the supply. Output voltage Vout1 shows an overshoot of 260 mV during high (100%) to low (10%) load step. During a low (10%) to high (100%) load step an undershoot of 288 mV occurs.

Figure 7 shows 100Hz line suppression (-62dB) at main output voltage Vout1. Only 63.6 mV peak-peak ripple is present at the output under worst case (low line voltage, high output load) conditions.

Figure 8 shows the 77 kHz switching frequency ripple (-65dB) present at the output. The switching frequency ripple is about 43 mV under worst case conditions.

Table 1 and figures 4 to 8 show the load regulation of Vout1 and the (cross) load regulation of the other outputs. With regard to a comparable fly back converter this is an extremely good cross regulation

5.6 Start-up

The TEA1610 is supplied by the applied voltage on the Vdd pin. At a Vdd voltage of 4V the low side MOSFET is conducting and the high side MOSFET does not conduct. This start-up output state guarantees the initial charging of the bootstrap capacitor which is used for the floating supply of the high side driver.

During start-up, the voltage across the frequency capacitor C₁₇ is zero to have a defined start-up. The output voltage of the error amplifier is kept on a constant voltage of 2.7V, which forces a current through R4 that results in a maximum starting frequency (fmax). The start-up state will be maintained until the Vdd voltage reaches the start level of 13.5V, the oscillator is activated and the converter starts operating

The total start-up time is low (less than approx. 600ms.) and no overshoots are presented on Vout1 (80V) during start-up. The initial primary start-up current is kept lower than the OCP level. This is done via the soft start option of the TEA1610 via soft start capacitor C31. Soft start can also be done secondary with an additional circuit R11, R18, C22 and D16. A disadvantage of this circuit is that during the first switching stage the primary current can still be higher than the OCP level. With the TEA1610 this circuit is not necessary and via the soft start capacitor this disadvantage will be avoided.

5.7 Protections

5.7.1 Under Voltage Lock Out (UVLO) and Short Circuit Protection

When the voltage level V_{aux} becomes too low the controller stops its operation (UVLO). This feature enables the safe restart mode during which the controller is alternately active and not active.

When the main output (V_{out1}) gets short circuited, the controller supply voltage V_{aux} will drop because the transformer take-over winding 1-2 fails to charge capacitors C17 and C20. V_{aux} drops below UVLO and the controller enters safe restart mode. This situation persists until the short circuit is removed.

5.7.2 Over Voltage Protection (OVP)

When the voltage level V_{aux} becomes too high the controller also stops its operation (OVP). Because V_{aux} is a reflection of the output voltage, this feature limits the output voltage level.

5.7.3 Over Current Protection (OCP)

When the (primary) resonant current becomes too large the controller stops its operation. This protects the MOSFETs for failure due to large currents. The current is measured by R_{35} , that converts it to a voltage, which can activate the ShutDown (SD) via D_{14} . During start-up the first period of the resonant current contains an amplitude that exceeds the OCP_level. To avoid that the controller stops its operation the SD is kept low during start-up for a short while (about 600ms), with an additional circuit, see chapter7, page 20.

6 MEASUREMENTS

6.1 Static performance

Output	Load	$I_{OUT1}=30\text{mA}$	$I_{OUT1}=75\text{mA}$	$I_{OUT1}=150\text{mA}$	$I_{OUT1}=250\text{mA}$
V_{OUT1} 80V		80.0 V	80.0 V	80.0 V	80.0 V
V_{OUT2} 190V	30mA	193.0 V	193.2 V	193.6 V	193.9 V
	75mA	192.7 V	193.0 V	193.2 V	193.5 V
	150mA	192.5 V	192.7 V	193.0 V	193.2 V
	250mA	192.3 V	192.5 V	192.8 V	193.0 V
V_{OUT3} 13V	0 mA	12.9 V	12.9 V	12.9 V	13.0 V
	250 mA	12.5 V	12.6 V	12.6 V	12.7 V
	500 mA	12.2 V	12.3 V	12.4 V	12.5 V
	1.00 A	11.7 V	11.8 V	12.0 V	12.1 V
V_{OUT4} -13V	0 mA	- 12.9 V	- 12.9 V	- 12.9 V	- 12.9 V
	250 mA	- 12.4 V	- 12.4 V	- 12.5 V	- 12.5V
	500 mA	- 12.1 V	- 12.2 V	- 12.3 V	- 12.3 V
	1.00 A	- 11.7 V	- 11.7 V	- 11.8 V	- 11.9 V
V_{OUT5} -6.2V	0 mA	- 6.38 V	- 6.38 V	- 6.38 V	- 6.38 V
	325mA	- 6.38 V	- 6.38 V	- 6.38 V	- 6.38 V
	650mA	- 6.32 V	- 6.32 V	- 6.32 V	- 6.32 V
V_{OUT6} 5V	0 mA	5.03 V	5.03 V	5.03 V	5.03 V
	50 mA	5.03 V	5.03 V	5.03 V	5.03 V

Table 1 Load and cross load regulation (@ $V_{line}=230V_{RMS}$), all measured values are in V_{DC} , with -6.3V and 5.0V post regulated.

V_{line} (V_{RMS})	P_{OUT} (W)	P_{IN} (W)	Efficiency (%)
90	0	7.1	-
	42.4	54.0	79
	85.6	102.6	83
230	0	8.8	-
	42.4	54.7	78
	85.6	103.4	83
276	0	9.8	-
	42.4	56.2	75
	85.6	103.4	83

Table 2 Efficiency performance (@ load spread over all outputs), with -6.3V and 5.0V post regulated.

V_{line} (V_{RMS})	P_{OUT} (W)	P_{IN} (W)	Efficiency (%)
90	0	6.8	-
	44.3	53.7	82
	89.3	102.3	87
230	0	6.7	-
	44.3	52.6	84
	89.3	101.3	88
276	0	6.8	-
	44.3	53.2	83
	89.3	100.4	89

Table 3 Efficiency performance (@ load spread over all outputs). minus the losses in start-up resistor and with the improved transformer, which contains a separate winding for the $-6.3V$.

Measurements of table 2, and 3 are done with load spread over all outputs !!!!!!!

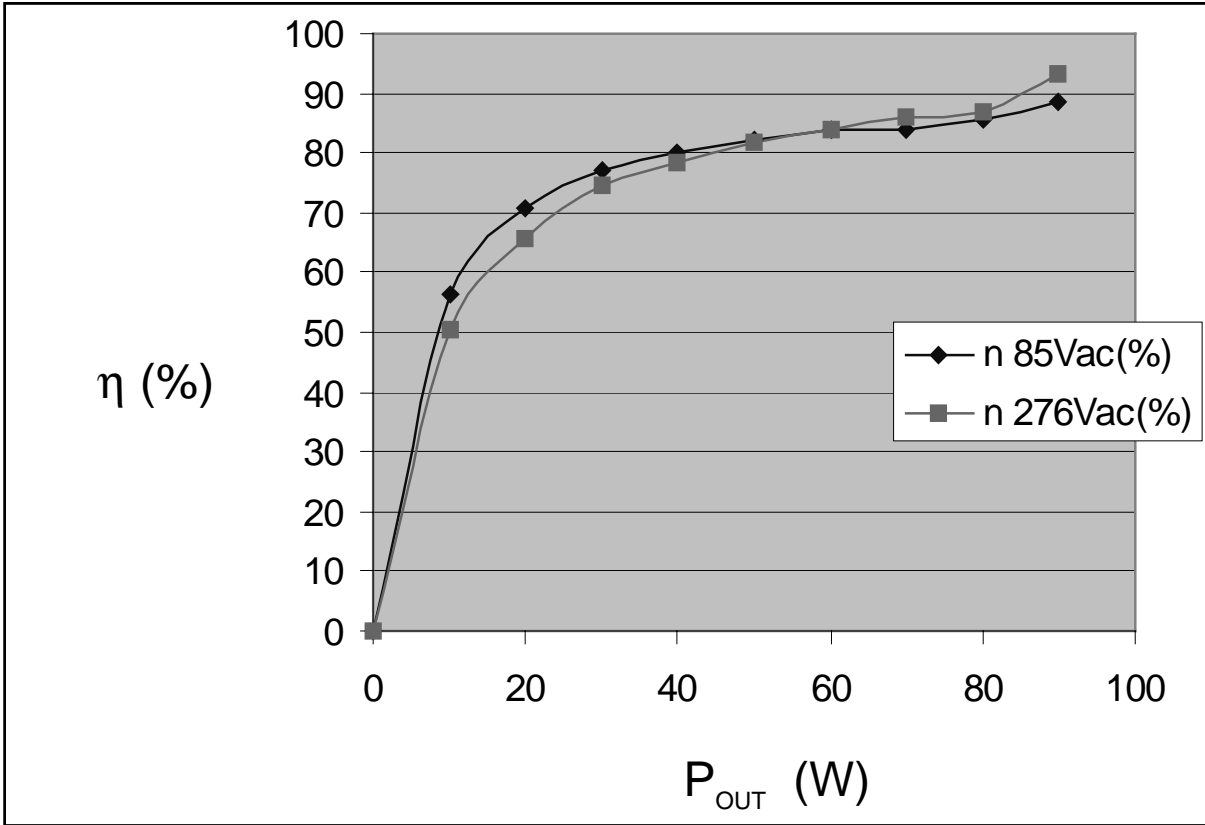

Figure 3 Efficiency as function of the output power, measurement done with load spread over V_{OUT1} and V_{OUT2}

NOTE: The load in the graph above is spread over two outputs. Because of that the diode losses are less and the measured efficiency is better than that of table 2 and 3, where the load is spread over all outputs.

Temperature measurements @ $T_{ambient} = 21^{\circ}C$:

- $T_{CORE} = 46^{\circ}C$ → $\Delta T = 25^{\circ}C$ (near air gap)
- $T_{WIRE} = 45^{\circ}C$ → $\Delta T = 24^{\circ}C$
- $T_{HEAT\ SINK} = 43^{\circ}C$ → $\Delta T = 22^{\circ}C$ (near MOSFETs)
- $T_{BODY\ MOSFET} = 42^{\circ}C$ → $\Delta T = 21^{\circ}C$
- $T_{TIE\ POINT\ MOSFET} = 46^{\circ}C$ → $\Delta T = 25^{\circ}C$
- $T_{TIE\ POINT\ 190V\ DIODE} = 46^{\circ}C$ → $\Delta T = 25^{\circ}C$
- $T_{TIE\ POINT\ 80V\ DIODE} = 41^{\circ}C$ → $\Delta T = 20^{\circ}C$

6.2 Dynamic performance

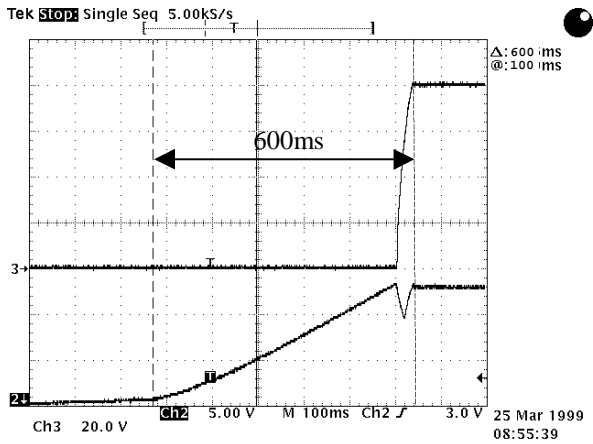

Figure 4 Start-up behaviour (@ $V_{line}=230V_{AC}$, $I_{OUT}=250mA$)

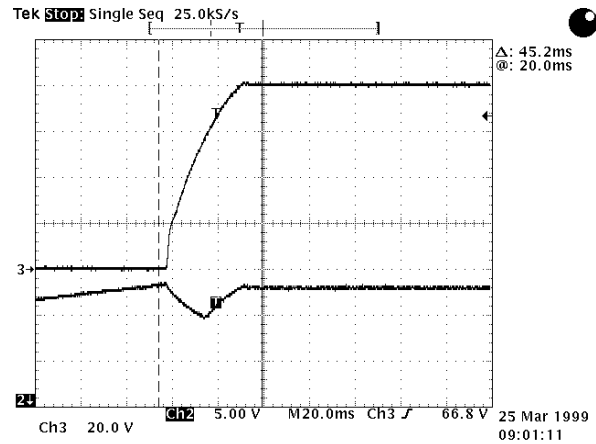

Figure 5 Start-up behaviour (@ $V_{line}=230V_{AC}$, $I_{OUT}=250mA$)

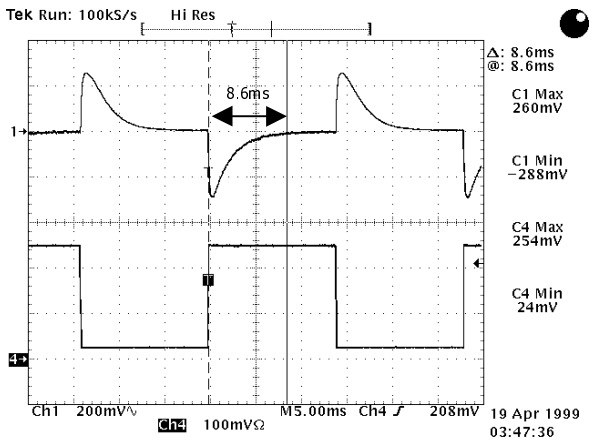

Figure 6 Load step response (@ $V_{line}=230V_{AC}$, $I_{OUT}=25 - 250mA$)

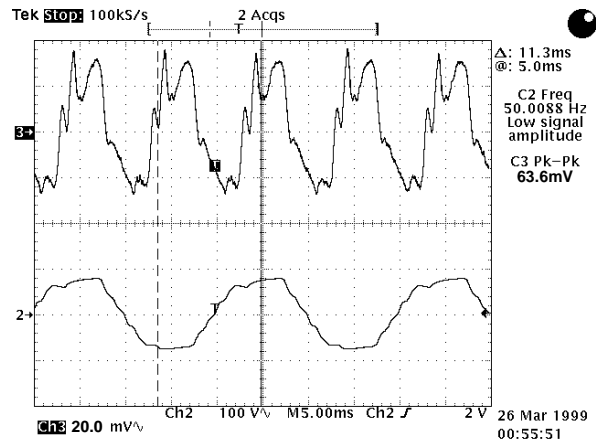

Figure 7 V_{OUT1} 100Hz ripple (@ $V_{LINE}=90V_{AC}$, $I_{OUT1}=250mA$)

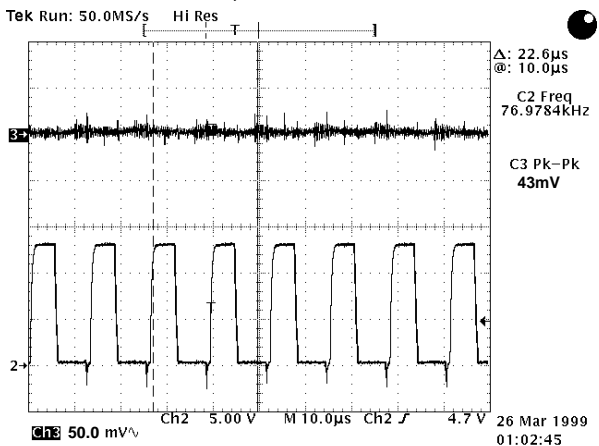

Figure 8 V_{OUT1} 77kHz ripple (@ $V_{LINE}=90V_{AC}$, $I_{OUT1}=250mA$)

Figure 6 → 288mV load step response = -49dB

Figure 7 → 63.6mV 100Hz ripple = -62dB

Figure 8 → 43mV 77kHz ripple = -65dB

6.3 Bode diagrams

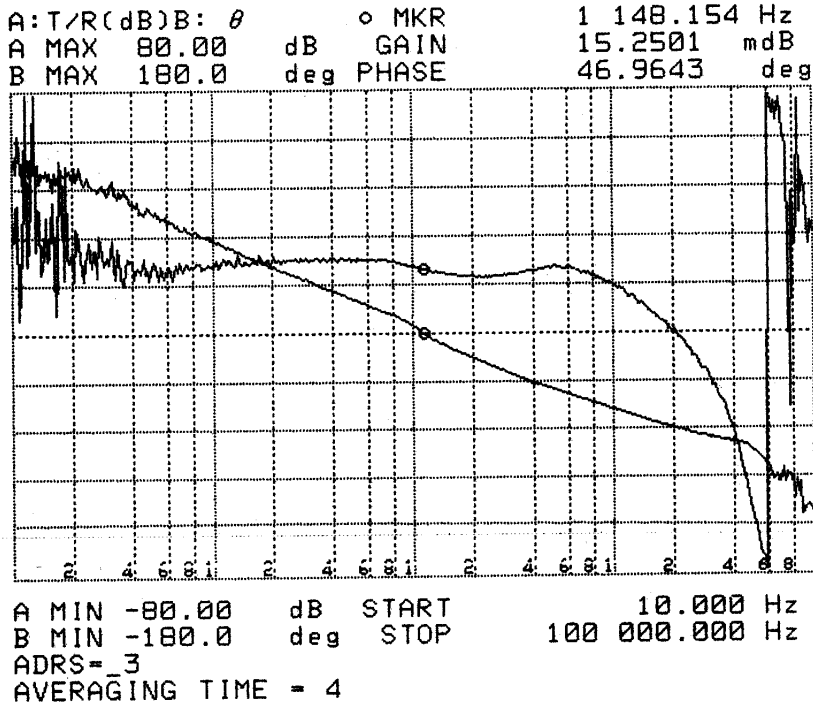

Figure 9 Bode plot control loop with $V_{in} = 85V_{AC}$ at full load

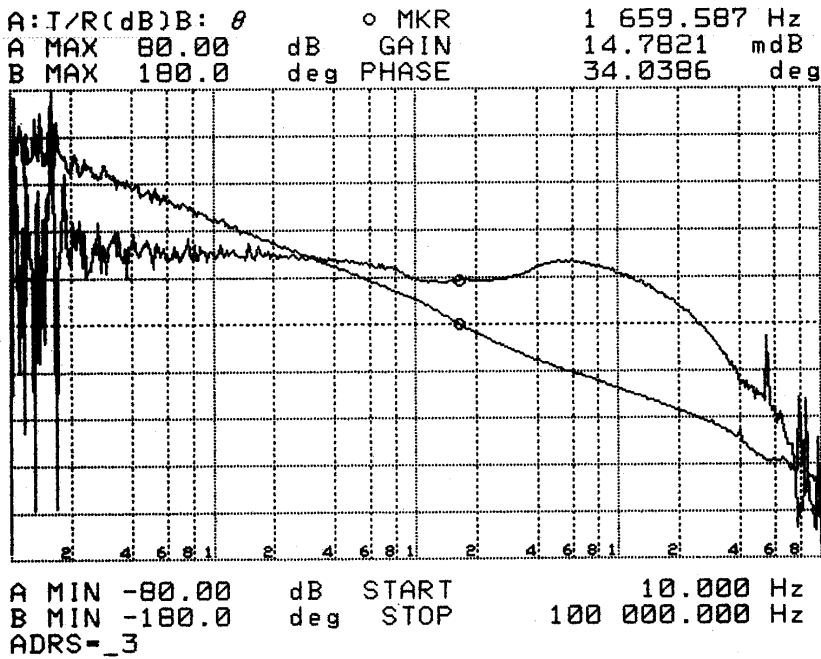

Figure 10 Bode plot control loop with $V_{in} = 276V_{AC}$ at full load

6.4 EMI results

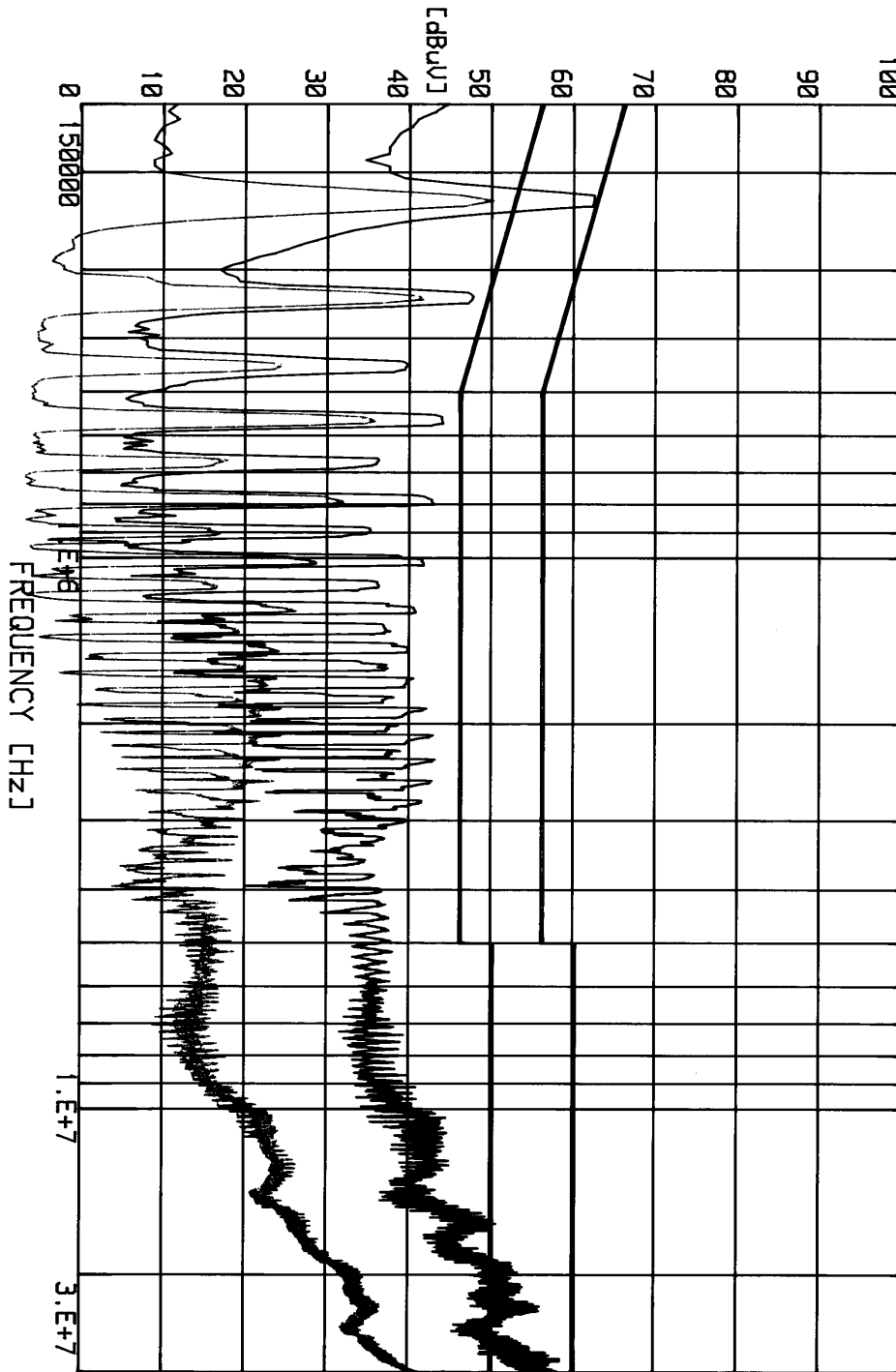
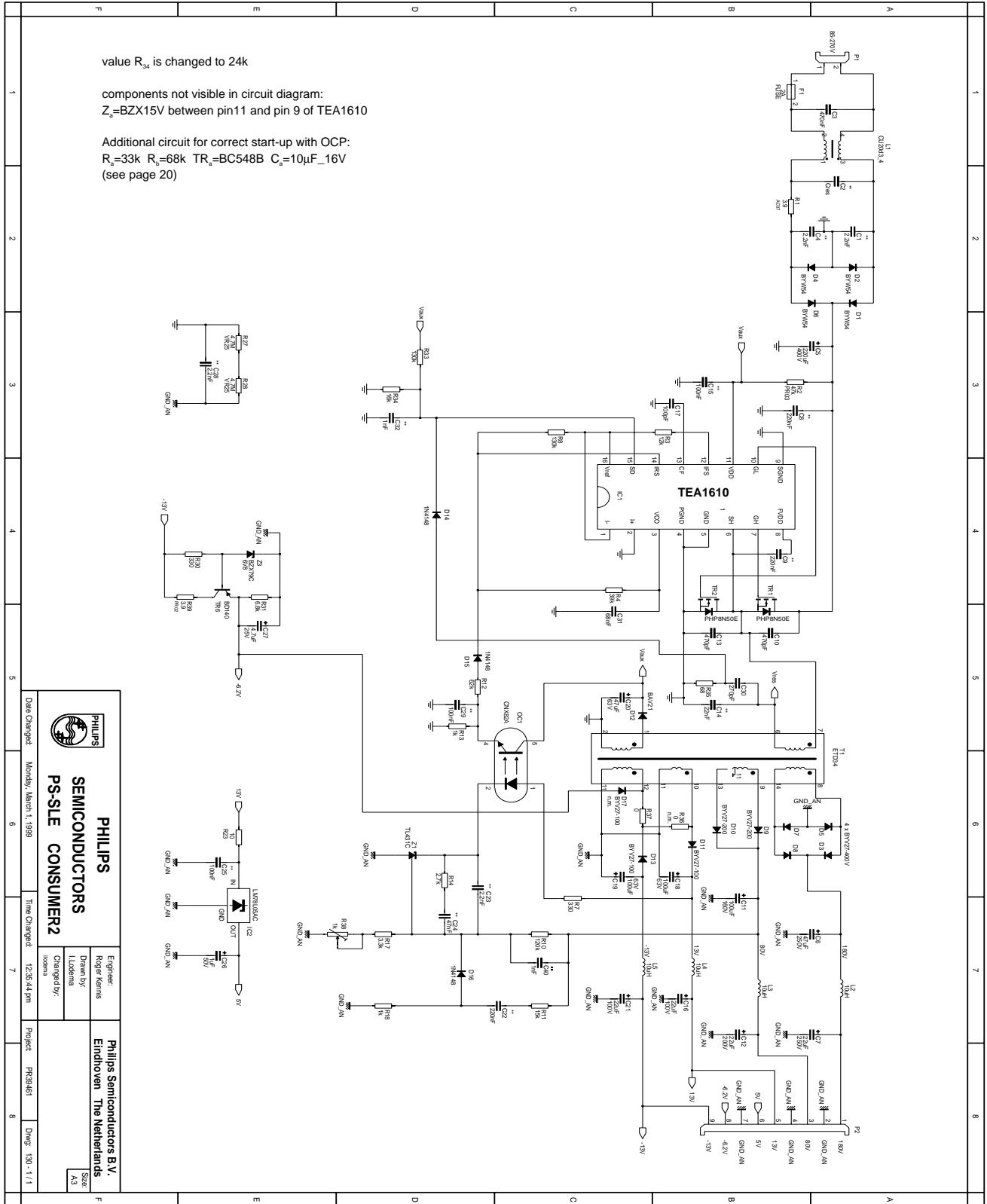

Figure 11 CISPR13/22 measurement (150kHz-30MHz) (@ $V_{line}=230V_{AC}$, $R_{OUT1}=273\Omega$, $R_{OUT2}=659\Omega$, $I_{OUT1}=293mA$, $I_{OUT2}=293mA$)

7 CIRCUIT DIAGRAM



<p>PHILIPS SEMICONDUCTORS</p>		<p>PHILIPS SEMICONDUCTORS B.V. Eindhoven The Netherlands</p>	
<p>PS-SLE CONSUMER2</p>		<p>Engineer: Ropyr Kernis Drawn by: T.Boerhans Changed by: [blank] Version: A3</p>	
<p>Date Changed: Monday, March 1, 1999</p>		<p>Time Changed: 12:35:44 pm</p>	
<p>Project: PR33461</p>		<p>Dwg#: 130-1/1</p>	

Additional circuit for correct start-up with OCP:

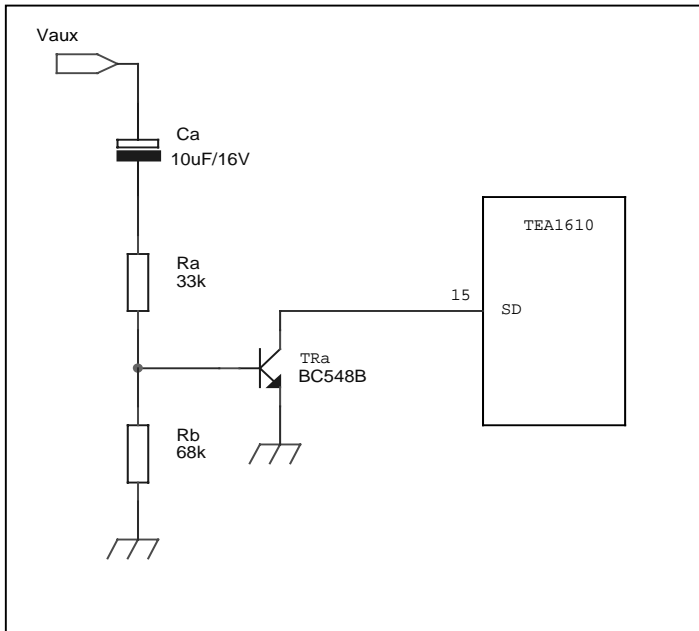

8 LAYOUT CONSIDERATIONS

See next page for the implementation.

General guidelines:

- Minimise area of loops that carry high di/dt current transients (transformer in- and output loops)
- Minimise area of traces and components with high dV/dt voltage excitation; reduce trace lengths and component size
- Keep functional circuit blocks close together
- Keep transformer, resonance capacitor C14, TEA1610 and input capacitor C5 as close as possible to each other such that the main current loop area is as small as possible

Layout flow:

1. Start layout with high current (large signal) primary circuit:
 - Minimise high current AC-loop area (transformer, TEA1610, input capacitor C5)
 - Minimise bridge traces (TEA1610 pin6, source TR1 and drain TR2) surface area
 - Minimise dV/dt limiter loop areas (C10 and C13 close as possible to MOSFETs)
2. Continue with the output AC loops:
 - Minimise AC loop areas (start with high current output)
3. Continue with the controller section:
 - Compact set-up
 - Keep Signal Ground (SGND) and Power Ground (PGND) separated on PCB, but short connection of pin4 to pin9
4. Continue with regulator section:
 - Compact set-up
5. GND of input capacitor C5 with a short track via safety capacitor C28 to output capacitor C6 and C11
6. Avoid HF interference between mains filter section (C2, L1, C3) and connector P1 coming from circuits that carry high di/dt 's (magnetic interference)

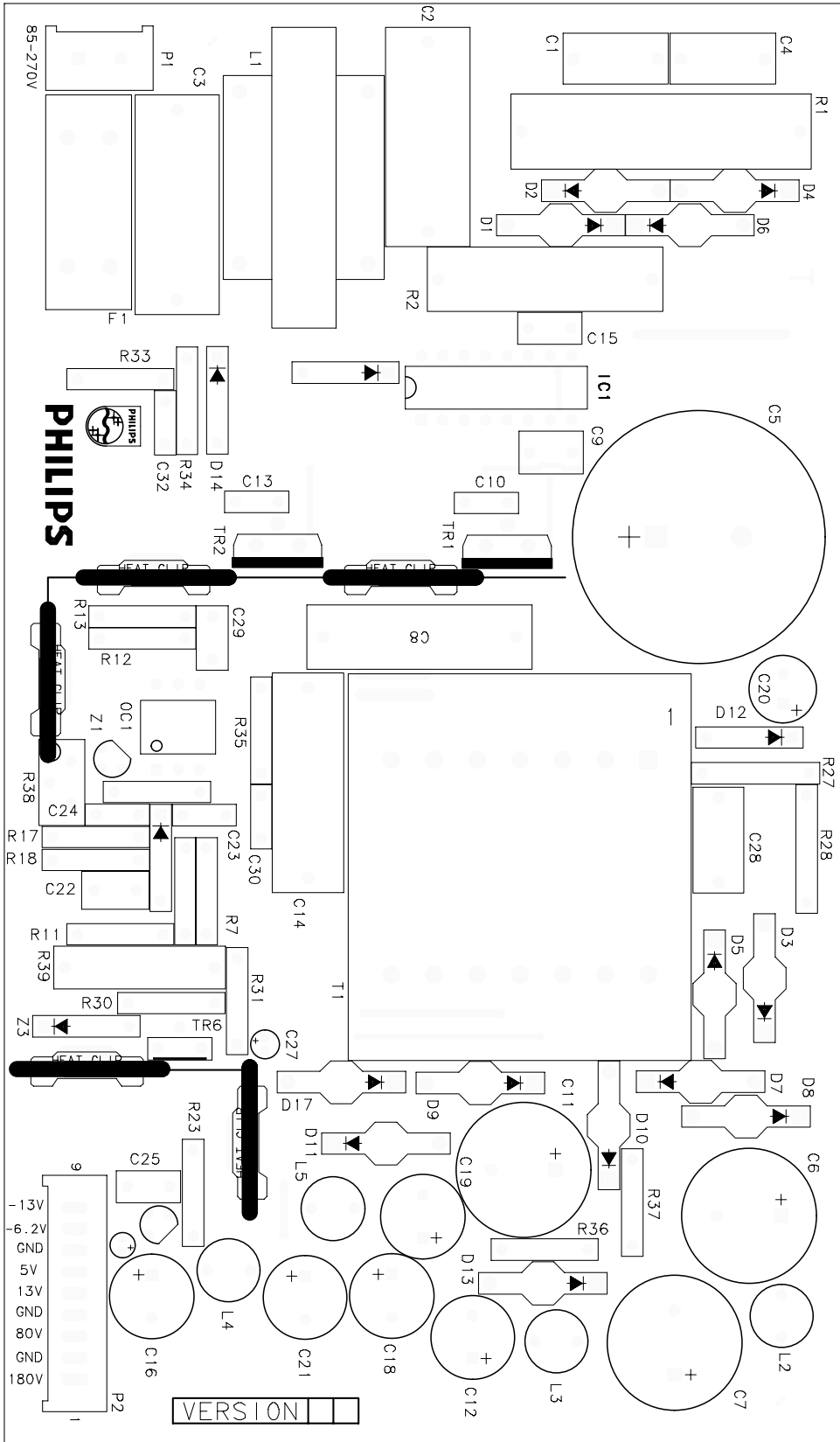

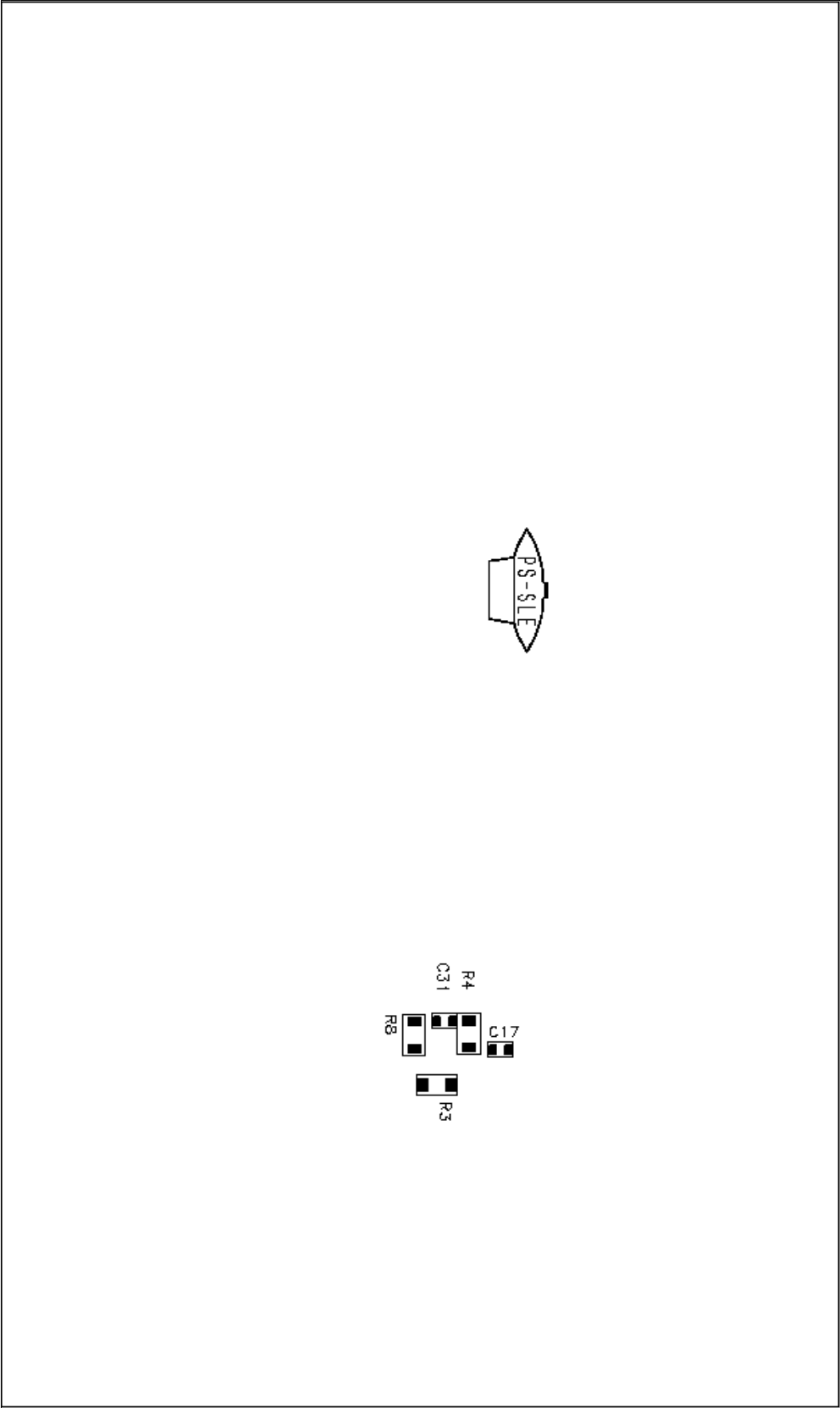

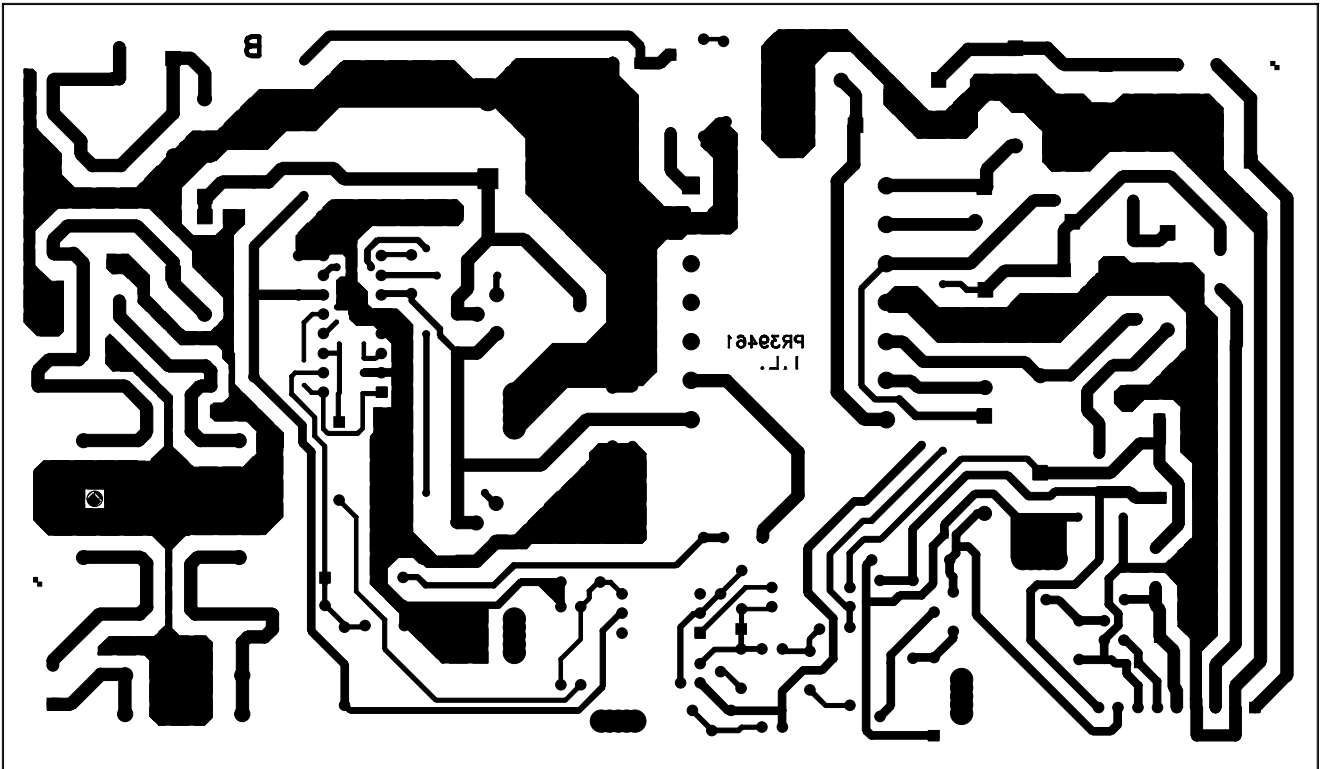

9 PARTS LIST

REFERENCE	VALUE	SERIES	TOL	RATING	GEOMETRY	12NC_NO
Capacitors						
C1 C4 C28	2.2nF	MKP 336	20%	250V	C_B6_L12.5_P10mm	2222-336-60222
C2	Cres	MKT-P 330	20%	250V	C_B10_L26_P22mm5	2222-330-40334
C3	470nF	MKP 336	20%	275V	C_B10_L26_P22mm5	2222-336-20474
C5	220uF	PSM-SI 057	20%	400V	CASE_3050	2222-057-36221
C6	47uF	RLH 151	20%	250V	CASE_R19	2222-151-63479
C7	22uF	RLH 151	20%	250V	CASE_R19a	2222-151-93229
C8	220nF	MKT 368	10%	400V	C368_I	2222-368-55224
C9	220nF	MKT 370	10%	63V	C370_C	2222-370-21224
C10 C13	470pF	C655	10%	500V	CER2_2A	2222-655-03471
C11	100uF	RLH 151	20%	160V	CASE_R19	2222-151-61101
C12	22uF	RLH 151	20%	200V	CASE_R16	2222-151-62229
C14	22nF	KP/MMKP 376	5%	1000V	C_B8.5_L26_P22mm5	2222-376-72223
C15 C25 C29	100nF	MKT 370	10%	63V	C370_B	2222-370-21104
C16 C21	22uF	RVI136	20%	100V	CASE_R14	2222-136-69229
C17	100pF	NPO	5%	50V	C0805	2222-861-12101
C18 C19	100uF	RVI136	20%	63V	CASE_R15	2222-136-68101
C20	47uF	RSM 037	20%	63V	CASE_R13_m	2222-037-58479
C22	220nF	MKT 465	10%	100V	C_B4.5_L8_P5mm	2222-465-06224
C23	22nF	MKT 370	10%	100V	C370_A	2222-370-21223
C24	47nF	MKT 370	10%	100V	C370_A	2222-370-21473
C26	1uF	RLP5 134	20%	50V	CASE_R51_CA	2222-134-51108
C27	4.7uF	RLP5 134	20%	25V	CASE_R52_CA	2222-134-56478
C30	270pF	C655	10%	500V	CER2_1	2222-655-03271
C31	68nF	X7R	10%	50V	C0805	2222-590-16638
C32	1nF	MKT 370	10%	400V	C370_A	2222-370-51102
Diodes						
D1 D2 D4 D6	BYW54	Rectifier		600V	SOD57	9333-636-10153
D3 D5 D7 D8	BYV27-400	Rectifier		400V	SOD57	9340-366-90133
D9 D10	BYV27-200	Rectifier		200V	SOD57	9335-526-80112
D11 D13	BYV27-100	Rectifier		100V	SOD57	9335-435-00133
D12	BAV21	Gen_Purpose			SOD27	9331-892-10153
D14 D15 D16	1N4148	Gen_Purpose			SOD27	9330-839-90153
D17	BYV27-100	Rectifier		100V	SOD57	9335-435-00133
Fuse						
F1	2A	SLOW			GLAS HOLDER	2412-086-28239
Ics						
IC1	TEA1610	IC_Universal			SOT38_s	
IC2	LM78L05 AC	Stab_Pos			TO92	

Inductors						
L2 L3 L4 L5	10uH	TSL0709	10%		TSL0707_2e	
Opto coupler						
OC1	CNX82A	CNX			SOT231	9338-846-80127
Connectors						
P1	MKS373 0_2p_22 0V	MKS3730			MKS3730_2p_220V	
P2	MKS373 0_9p	MKS3730			MKS3730_9p	
Resistors						
R1	3.3	AC07	5%	7W	AC07	2322-329-07338
R2	47k	PR03	5%	3W	PR03	2322-195-13473
R3	12k	RC01	5%	0.25W	R1206	2322-711-61123
R4	39k	RC01	5%	0.25W	R1206	2322-711-61393
R7	470	SFR25H	5%	0.5W	SFR25H	2322-186-16471
R8	130k	RC01	5%	0.25W	R1206	2322-711-61134
R10	120k	SFR25H	5%	0.5W	SFR25H	2322-186-16124
R11	15k	SFR25H	5%	0.5W	SFR25H	2322-186-16153
R12	62k	SFR25H	5%	0.5W	SFR25H	2322-186-16623
R13 R18	1k	SFR25H	5%	0.5W	SFR25H	2322-186-16102
R14	2.7k	SFR25H	5%	0.5W	SFR25H	2322-186-16272
R17	3.3k	SFR25H	5%	0.5W	SFR25H	2322-186-16332
R23	10	SFR25H	5%	0.5W	SFR25H	2322-186-16109
R27 R28	4.7M	VR25	5%	0.25W	VR25	2322-241-13475
R30	330	SFR25H	5%	0.5W	SFR25H	2322-186-16331
R31	6.8k	SFR25H	5%	0.5W	SFR25H	2322-186-16682
R33	120k	SFR25H	5%	0.5W	SFR25H	2322-186-16124
R34	24k	SFR25H	5%	0.5W	SFR25H	2322-186-16243
R35	68	SFR25H	5%	0.5W	SFR25H	2322-186-16689
R36	n.m.	SFR25H	5%	0.5W	SFR25H	2322-181-90019
R37	0	SFR25H	5%	0.5W	SFR25H	2322-181-90019
R38	1k	3296Y	10%	0.5W	BO3296Y	2122-362-00723
R39	3.9	PR02	5%	2W	PR02	2322-194-13398
Transistors						
TR1 TR2	PHP8N5 0E	fets			TO220	9340-438-80127
TR6	BD140	Pow_Low_Freq			TO126	9330-912-30127
Transformer						
T1	ETD34	Switch_Mode			ETD34	8228-001-34471
Zener diodes						
Z1	X	Misc			TO226AA	
Z3	BZX79C	BZX79C		6V8	SOD27	9331-177-50153

10 REFERENCES

- 1 M.K. Kazimierczuk & D. Czarkowski, Resonant Power Converters, 1995 Wiley Interscience, ISBN 0-471-04706-6